

selezione di tecnica radio-tv

2 a

1961

numero speciale dedicato
alle parti staccate G.B.C.

SELEZIONE DI TECNICA RADIO - TV, - SUPPLEMENTO AL N. 2 - 1961

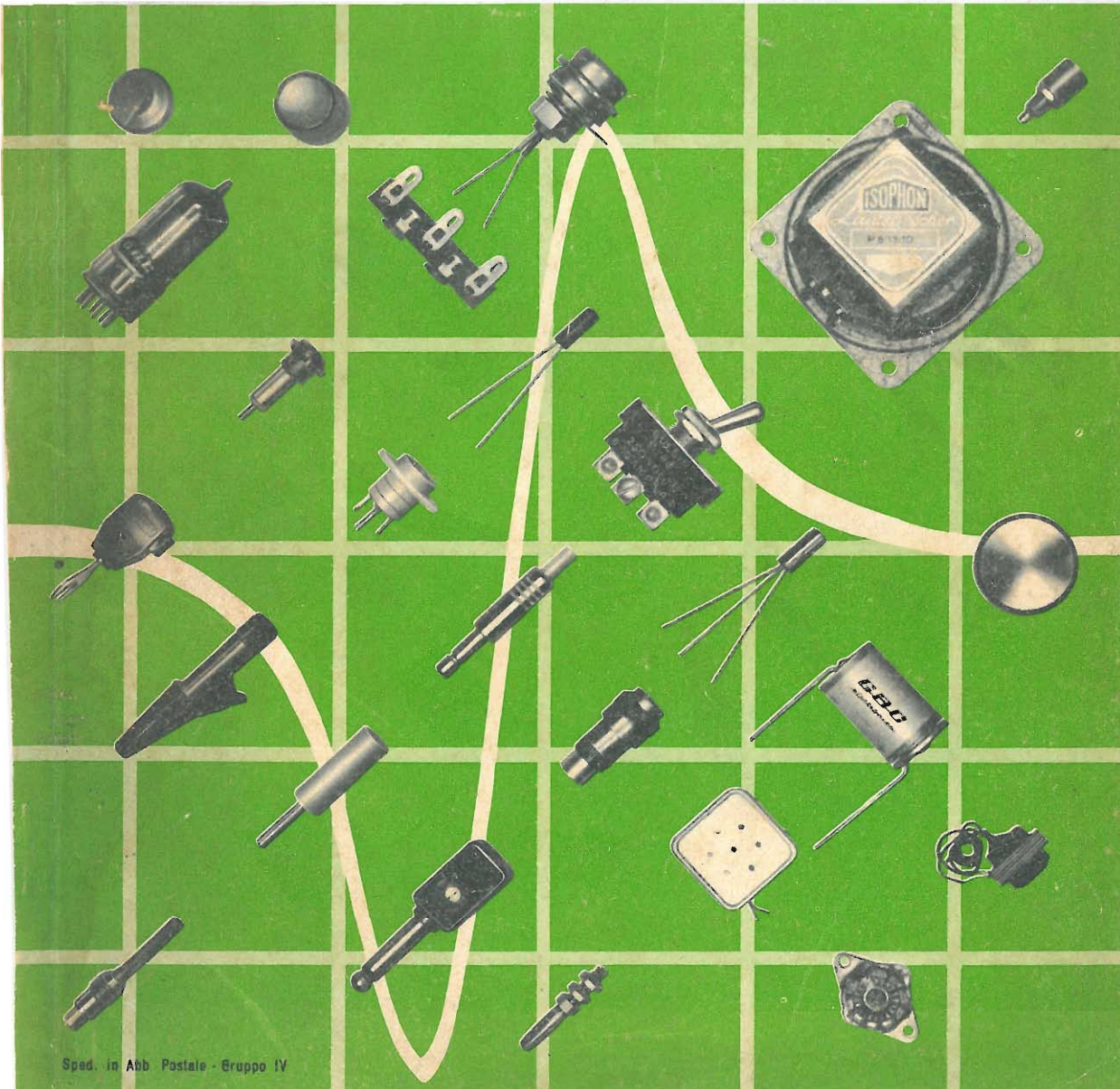

Riservato ai:

**TECNICI
RIVENDITORI
NEGOZIANTI**



CONDIZIONI DI VENDITA

I prezzi si intendono franco Milano, le spedizioni effettuate **contro assegno**. Imballo porto e bolli a carico del cliente. Si dà la precedenza alle ordinazioni accompagnate da importi anticipati. Le spedizioni vengono eseguite tenute presente le disponibilità di magazzino. **I prezzi segnati sul presente listino non sono impegnativi**. Variazioni impreviste dovute ad eventuali oscillazioni dei cambi, provvedimenti doganali, dazi, od altre cause impreviste, porteranno per conseguenza la variazione dei prezzi del presente Listino **senza alcun obbligo di preventivo avviso**. Non si riceve merce di ritorno. La merce viaggia a rischio e pericolo del committente. Per ogni contestazione il Foro competente è quello di Milano o della città Sede dell' Agenzia che ha effettuato la vendita. Si declina ogni responsabilità relativa a spese accessorie per merci commissionate e non ritirate.

Il presente listino annulla i precedenti ed è riservato ai soli negozianti, rivenditori e tecnici.

Per le rimesse, preghiamo prendere nota del nostro numero di Conto Corrente Postale: 3/23395.

GLI ARTICOLI NON RIPORTATI SUL PRESENTE LISTINO, S'INTENDONO ESAURITI.

	Articolo	CONDENSATORI CERAMICI Condensatori ceramici a perlina « Philips » Assortimento N. 1 50 pezzi in 13 valori così suddivisi: N. 2 da 3 pF N. 3 da 270 pF » 2 » 6,8 pF » 3 » 330 pF » 3 » 22 pF » 6 » 680 pF » 6 » 47 pF » 5 » 820 pF » 4 » 100 pF » 3 » 1.000 pF » 5 » 220 pF » 4 » 1.500 pF » 4 » 2.200 pF	Prezzo listino
	B/1		2300
	B/2	Assortimento N. 2 50 pezzi in 13 valori così suddivisi: N. 4 da 4,7 pF N. 5 da 220 pF » 4 » 10 pF » 5 » 330 pF » 2 » 22 pF » 5 » 470 pF » 2 » 47 pF » 5 » 680 pF » 3 » 56 pF » 2 » 820 pF » 5 » 150 pF » 4 » 1.000 pF » 4 » 1.500 pF	2300
	B/3	Condensatori ceramici a tubetto « Philips » Assortimento N. 3 50 pezzi in 13 valori così suddivisi: N. 3 da 15 pF N. 4 da 820 pF » 3 » 47 pF » 5 » 1.500 pF » 4 » 68 pF » 6 » 3.300 pF » 4 » 100 pF » 6 » 6.800 pF » 4 » 270 pF » 3 » 10.000 pF » 4 » 470 pF » 3 » 15.000 pF » 1 » 22.000 pF	2300
	B/4	Assortimento N. 4 50 pezzi in 16 valori così suddivisi: N. 2 da 10 pF N. 5 da 1.000 pF » 2 » 22 pF » 5 » 1.500 pF » 2 » 56 pF » 5 » 2.200 pF » 2 » 100 pF » 5 » 3.300 pF » 3 » 150 pF » 5 » 4.700 pF » 3 » 220 pF » 1 » 10.000 pF » 3 » 330 pF » 1 » 15.000 pF » 5 » 680 pF » 1 » 22.000 pF	2300

Prezzo listino

Articolo

Condensatori ceramici a perlina « Philips »

Tensione di lavoro: 500 Vcc
 Tensione di prova: 1500 Vcc
 Resist. isolamento:
 50.000 MΩ da 1,8 a 18 pF
 10.000 MΩ da 18 a 2200 pF
 Tolleranza:
 da 1,8 a 2,2 pF: ± 0,5 pF
 da 2,7 a 5,7 pF: ± 1 pF
 da 6,8 a 150 pF: ± 20 %
 da 180 a 2200 pF: — 20 + 50 %
 Coefficiente di temperatura:
 da 3,3 a 18 pF — 330 ± 500 x 10⁻⁸/°C
 da 22 a 150 pF < 25 %
 da 180 a 2200 pF < 50 %
 Temperatura ammissibile:
 — 40 °C ÷ + 85 °C

Capacità pF	L mm	Capacità pF	L mm
3,3	5	82	8
3,9	5,5	100	9
4,7	6	120	6
5,6	6,5	150	6,5
6,8	7	180	6,5
8,2	5,5	220	7,5
10	6	270	8,5
12	7	330	8,5
15	8	390	6,5
18	9	470	7
22	5,5	680	9
27	6,5	820	10
33	7	1000	7
39	7,5	1200	7,5
47	8,5	1500	9
56	6,5	1800	10
68	7	2200	11,5



34 Condensatori da 3,3 a 470 pF

B/11

38 Condensatori da 680 a 2200 pF

B/12



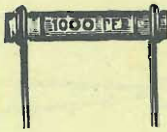

Articolo

Prezzo listino

Condensatori ceramici

a tubetto « Philips »

Tensione di lavoro: 500 Vcc

Tensione di prova: 1500 Vcc

Resist. isolamento: $\geq 50.000 \text{ M}\Omega$

a 20° C

Tolleranza:

da 1,8 a 2,2 pF: $\pm 0,25 \text{ pF}$

da 2,7 a 10 pF: $\pm 0,5 \text{ pF}$

da 12 a 470 pF: $\pm 5 \%$

Coefficiente di temperatura:

da 1,8 a 18 pF $-120 + 250 \times 10^{-6}/^{\circ}\text{C}$

da 22 a 470 pF $-750 \pm 120 \times 10^{-6}/^{\circ}\text{C}$

Temperatura ammissibile:

$-40^{\circ} \text{C} \div +85^{\circ} \text{C}$

Capacità pF	L mm	Capacità pF	L mm
1,8	12	47	12
2,2	12	56	12
2,7	12	68	12
3,3	12	82	12
3,9	12	100	12
4,7	12	120	14
5,6	12	150	16
6,8	12	180	18
8,2	12	220	20
10	12	270	22
12	12	330	26
15	12	470	34
18	12		
22	12		
27	12		
33	12		
39	12		

B/15

Condensatori da 1,8 a 470 pF

36

Condensatori ceramici

a tubetto « Philips »

Tensione di lavoro: 500 Vcc

Tensione di prova: 1500 Vcc

Resist. isolamento: $\geq 10.000 \text{ M}\Omega$

a 20° C

Tolleranza: $-20 + 50 \%$

Temperatura ammissibile:

$-40^{\circ} \text{C} \div +85^{\circ} \text{C}$

Capacità pF	$\phi \times L$ mm	Capacità pF	$\phi \times L$ mm
680	3,2x14	3.900	3,2x16
820	3,2x12	4.700	3,2x18
1.000	3,2x14	5.600	3,2x20
1.200	3,2x14	6.800	3,2x22
1.500	3,2x14	8.200	4,4x20
1.800	3,2x14	10.000	4,4x22
2.200	3,2x12	12.000	4,4x26
2.700	3,2x14	15.000	4,4x28
3.300	3,2x14	18.000	4,4x34
		22.000	4,4x40

B/16

Condensatori da 680 a 4700 pF

38

B/17

Condensatori da 5600 a 22.000 pF

56



Prezzo listino			Articolo
108	<p>Condensatori ceramici a disco con coefficiente di temperatura controllato Tensione di lavoro: 3500 Vcc Tensione di prova: 7500 Vcc Resistenza isolamento: $\geq 7500 \text{ M}\Omega$ Temperatura di lavoro: $-55 + 85 \text{ }^\circ\text{C}$ Coefficiente di temperatura: $-750 \pm 120 \times 10^{-8} \text{ }^\circ\text{C}$ Valore pF 120 e 150 Dimensioni: $\phi 15 \times 4 \text{ mm}$</p>		B/21
42	Capacità pF	ϕ mm	B/21-1
	10	6,4	
42	15	9,5	B/21-2
42	22	9,5	B/21-3
56	33	15	B/21-4
56	47	15	B/21-5
66	68	19	B/21-6
66	100	19	B/21-7
260	<p>Condensatori ceramici a disco Tensione di lavoro: 6.000 Vcc Tensione di prova: 12.000 Vcc Resist. isolamento: $\geq 10.000 \text{ M}\Omega$ Coefficiente di temperatura: $-750 \pm 15 \% \times 10^{-8} / ^\circ\text{C}$ Tolleranza: 10 % Valore: 82 pF Dimensioni: $\phi 22 \times 4 \text{ mm}$</p>		B/22



	Articolo	<p>Condensatori in polistirolo Tensione di lavoro: 125 Vcc Resist. isolamento a 100 Vcc + 20 °C, 80 % UR: $\geq 5 \cdot 10^{-5} \text{ M}\Omega$ Coefficiente di temperatura: — $150 \cdot 10^{-6}/^{\circ}\text{C}$ $\pm 50 \cdot 10^{-6}/^{\circ}\text{C}$ Frequenza di misura della capacit�: $\leq 1000 \text{ pF}$: 100 KHz $> 1000 \text{ pF}$: 100 Hz Tolleranza: 5 %</p>				Prezzo listino
	Capacit� pF		Capacit� pF			
		20	150	860	3.000	
		33	300	1.000	5.000	
		47	500	1.500	10.000	
		100	680	1.600	15.000	
		115	750	2.000	20.000	
					25.000	
		<p>Dimensioni: da 20 a 500 pF lungh.: mm 7 ± 2 \varnothing mm $3 \div 5,5$ da 680 a 1.000 pF lungh.: mm 10 ± 2 \varnothing mm $4,5 \div 5,5$ da 1500 a 5.000 pF lungh.: mm 15 ± 2 \varnothing mm $5 \div 8$ da 10.000 a 15.000 pF lungh.: mm 15 ± 2 - \varnothing mm $7,5 \div 12,5$ da 20.000 a 25.000 pF lungh.: mm 30 ± 2 - \varnothing mm $10 \div 13,5$</p>				
	B/25	Condensatori da 20 a 47 pF			34	
	B/26	Condensatori da 100 a 500 pF			30	
	B/27	Condensatori da 680 a 1000 pF			36	
	B/28	Condensatori da 1500 a 3000 pF			44	
	B/29	Condensatori da 5.000 pF			50	
	B/30	Condensatori da 10.000 pF			54	
	B/31	Condensatori da 15.000 pF			66	
	B/32	Condensatori da 20.000 pF			76	
	B/33	Condensatori da 25.000 pF			80	

Prezzo listino					Articolo
	Condensatori in polistirolo Tensione di lavoro: 250 Vcc Tolleranza: 5 %				
	Capacità pF		Capacità pF		
	100	500	1.500	10.000	
	115	680	1.600	15.000	
	150	750	2.000	20.000	
	200	860	3.000	25.000	
	300	1.000	5.000		
	Dimensioni: da 100 a 300 pF lungh.: mm 10 ± 2 \varnothing mm $4 \div 5,5$ da 500 a 5.000 pF lungh.: mm 15 ± 2 \varnothing mm $4 \div 9,5$ da 10.000 pF lungh.: mm 20 ± 2 \varnothing mm $8 \div 12,5$ da 15.000 pF a 25.000 pF lungh.: mm 30 ± 2 \varnothing mm $9,5 \div 14,5$				
30	Condensatori da 100 a 500 pF			B/26-1	
36	Condensatori da 680 a 1000 pF			B/27-1	
44	Condensatori da 1500 a 3000 pF			B/28-1	
50	Condensatori da 5.000 pF			B/29-1	
54	Condensatori da 10.000 pF			B/30-1	
66	Condensatori da 15.000 pF			B/31-1	
76	Condensatori da 20.000 pF			B/32-1	
80	Condensatori da 25.000 pF			B/33-1	



 	Articolo	<p>Condensatori in polistirolo Tensione di lavoro: 500 Vcc Tolleranza: 5 %</p> <table border="1"> <thead> <tr> <th colspan="2">Capacità pF</th> <th colspan="2">Capacità pF</th> </tr> </thead> <tbody> <tr> <td>20</td> <td>150</td> <td>860</td> <td>3.000</td> </tr> <tr> <td>33</td> <td>300</td> <td>1.000</td> <td>5.000</td> </tr> <tr> <td>47</td> <td>500</td> <td>1.500</td> <td>10.000</td> </tr> <tr> <td>100</td> <td>680</td> <td>1.600</td> <td>15.000</td> </tr> <tr> <td>115</td> <td>750</td> <td>2.000</td> <td>20.000</td> </tr> <tr> <td></td> <td></td> <td></td> <td>25.000</td> </tr> </tbody> </table> <p>Dimensioni: da 20 a 150 pF lungh.: mm 10±2 ∅ mm 4÷7 da 300 a 3.000 pF lungh.: mm 15±2 ∅ mm 5÷10,5 da 5.000 a 10.000 pF lungh.: mm 20±2 - ∅ mm 8,5÷13,5 da 15.000 a 25.000 pF lungh.: mm 30±2 - ∅ mm 11÷16</p>		Capacità pF		Capacità pF		20	150	860	3.000	33	300	1.000	5.000	47	500	1.500	10.000	100	680	1.600	15.000	115	750	2.000	20.000				25.000	Prezzo listino
	Capacità pF		Capacità pF																													
	20	150	860	3.000																												
	33	300	1.000	5.000																												
	47	500	1.500	10.000																												
	100	680	1.600	15.000																												
	115	750	2.000	20.000																												
				25.000																												
	B/25-2	Condensatori da 20 a 47 pF	34																													
	B/26-2	Condensatori da 100 a 500 pF	30																													
B/27-2	Condensatori da 680 a 1000 pF	36																														
B/28-2	Condensatori da 1500 a 3000 pF	44																														
B/29-2	Condensatori da 5.000 pF	50																														
B/30-2	Condensatori da 10.000 pF	54																														
B/31-2	Condensatori da 15.000 pF	66																														
B/32-2	Condensatori da 20.000 pF	76																														
B/33-2	Condensatori da 25.000 pF	80																														

Prezzo listino	Condensatori in polistirolo adatti per il montaggio su circuiti stampati Resist. isolamento a 100 Vcc + 20 °C, 80 % U.R.: $\geq 5 \cdot 10^{-5} \text{ M}\Omega$ Coefficiente di temperatura: — $150 \cdot 10^{-6}/^{\circ}\text{C} \pm 50 \cdot 10^{-6}/^{\circ}\text{C}$ Temperatura di lavoro — 10 °C + 70 °C Tolleranza: 5 %			Articolo
	Capacità pF	Vn c.c.	\varnothing x L circa mm	
44	3.000	125	6 x 15	B/33-4
50	5.000	125	8,5 x 17	B/33-5
54	10.000	125	9 x 22	B/33-6
64	15.000	125	11 x 22	B/33-7
76	20.000	125	10,5 x 33	B/33-8
80	25.000	125	11 x 33,5	B/33-9
44	2.000	250	6 x 15,5	B/34
44	3.000	250	7 x 16	B/34-1
50	5.000	250	9 x 16	B/34-2
54	10.000	250	10 x 22,5	B/34-3
64	15.000	250	10 x 32,5	B/34-5
76	20.000	250	11 x 32	B/34-6
80	25.000	250	13,5 x 33,5	B/34-7
34	1.000	500	6 x 16	B/34-8
44	1.500	500	7 x 17	B/34-9
44	2.000	500	8 x 17	B/34-11
44	3.000	500	9 x 17	B/34-12
50	5.000	500	9 x 17	B/34-13
54	10.000	500	12,5 x 24	B/34-14
64	15.000	500	13 x 34	B/34-15
76	20.000	500	13 x 34	B/34-16
80	25.000	500	15 x 34	B/34-17



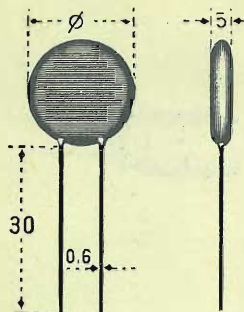

Articolo

Condensatori ceramici a dischetto
 Serie Bassa Tensione
 Tensione nominale 500 Vcc
 Tensione di prova 1500 Vcc
 Resist. isolamento ≥ 10000 Mohm
 Toll. sulla capacit  $-20\% +100\%$
 Finitura in rivestimento fenolico

Prezzo listino

	Capacit� pF	\varnothing mm	
B/35	470	6	34
B/35-1	680	6	34
B/35-2	1000	8	34
B/35-3	1500	8	36
B/35-4	2200	11	38
B/35-5	3300	11	38
B/35-6	4700	11	40
B/35-7	6800	15	44
B/35-8	10000	15	46

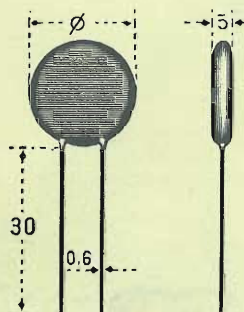

Condensatori ceramici a dischetto
 Serie Media Tensione
 Tensione nominale 1000 Vcc
 Tensione di prova 4000 Vcc
 Tensione di prova a 50 Hz 1500 Veff
 Toll. sulla capacit  $-20\% +100\%$
 Questo condensatore pu  sopportare picchi istantanei di 1500 V

	Capacit� pF	\varnothing mm	
B/36	470	8	42
B/36-1	680	8	42
B/36-2	1000	11	46
B/36-3	1500	11	52
B/36-4	2200	15	58
B/36-5	3300	15	62
B/36-6	4700	15	62
B/36-7	6800	19	72
B/36-8	10000	19	72

Prezzo listino			Articolo
	Condensatori ceramici a dischetto con coefficiente di temperatura controllato Impiego: correzione di deriva termica nei ricevitori radio e TV. Tensione nominale 500 Vcc Tensione di prova 1500 Vcc Resistenze isolamento >10000 Mohm Tolleranza sulla capacità $C < 10 \text{ pF} \pm 0,5 \text{ pF}$ $C > 10 \text{ pF} \pm 20 \%$ Coefficiente di temperatura $-750 \pm 250 \text{ in } 10^{-6}/^{\circ}\text{C}$		
	Capacità pF	\varnothing mm	
36	4,7	6	B/37
36	5,6	6	B/37-1
36	6,8	6	B/37-2
36	8,2	6	B/37-3
36	10	6	B/37-4
36	15	8	B/37-5
36	22	8	B/37-6
36	33	8	B/37-8
40	39	11	B/37-9
40	47	11	B/38
40	56	11	B/38-1
40	68	11	B/38-2
50	82	15	B/38-3
50	100	15	B/38-4
50	120	15	B/38-5
68	150	19	B/38-6
68	180	19	B/38-7
68	220	19	B/38-8

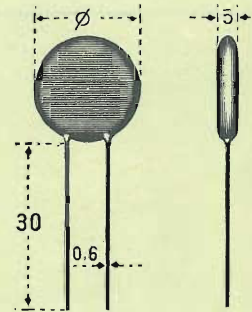

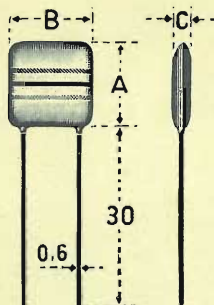

Articolo				Prezzo listino	
	Condensatori ceramici a piastrina bassa tensione				
	Tensione nominale	30 Vcc			
	Tensione di prova	90 Vcc			
	Angolo di perdita	$\leq 400 \cdot 10^{-4}$			
	Resist. isolamento	≥ 5000 Mohm			
	Tolleranza sulla capacit�	+80 — 20%			
	Capacit�	Dimensioni in mm			
	pF	A	B	C	
B/39-1	4.700	6	6	3	68
B/39-3	10.000	10	10	3	72
B/39-5	25.000	10	10	3	74
B/39-7	50.000	12	12	3	84
B/39-9	100.000	15	15	3	114

Condensatori a carta metallizzata in custodia di plastica.
Tolleranza sulla capacit  $\pm 20\%$
Resistenza d'isolamento
200 Mohm $\times \mu\text{F}$ a 20 °C
Angolo di perdita $100 \cdot 10^{-4}$ a 20 °C a 1 kc

Serie ultraminiatura

	Capacit�	Vn cc	$\varnothing \times L$	
	pF		mm	
B/40	4.000	150 V	4,5 x 11	36
B/40-1	5.000	150 V	4,5 x 11	36
B/40-2	10.000	150 V	4,5 x 11	36
B/40-3	20.000	150 V	6,3 x 14	42
B/40-4	30.000	150 V	6,3 x 14	48
B/40-5	40.000	150 V	6,4 x 14	48
B/41	1.000	400 V	4,5 x 11	36
B/41-1	2.000	400 V	4,5 x 11	36
B/41-2	3.000	400 V	4,5 x 11	36
B/41-3	5.000	400 V	6,3 x 14	46
B/41-4	10.000	400 V	6,3 x 14	46

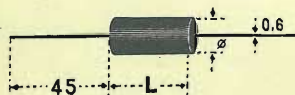

Prezzo listino	Condensatori a carta metallizzata in custodia di plastica.			Articolo
	Serie miniatura			
	Capacità pF	Vn cc	∅ x L mm	
72	100.000	150 V	9,5 x 22	B/42
94	250.000	150 V	12,5 x 22	B/42-1
114	500.000	150 V	12,5 x 35	B/42-2
188	1 μF	150 V	16 x 35	B/42-3
292	2 μF	150 V	17,5 x 47	B/42-4
72	25.000	350 V	9,5 x 22	B/43
94	50.000	350 V	12,5 x 22	B/43-1
104	100.000	350 V	12,5 x 35	B/43-2
156	250.000	350 V	16 x 35	B/43-3

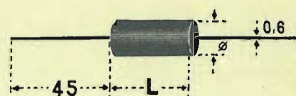

PREGHIAMO CORTESEMENTE CHIUNQUE INTERESSATO ALLA PRESENTE PUBBLICAZIONE DI VOLERSI ASTENERE DALL'IMITARLA NELLA SUA VESTE, NELLE SUE ILLUSTRAZIONI E NEI SUOI DATI, ANCHE PARZIALMENTE.

Articolo	Condensatori in polistirolo Fattore di potenza $\text{tang. } \delta$; a 1 kHz; 20 °C: $\leq 5 \times 10^{-4}$ Resistenza isolamento: $\geq 10^6 \text{ M}\Omega$ a 20° C Temperatura di lavoro $-30 \text{ }^\circ\text{C} \div +75 \text{ }^\circ\text{C}$ Umidità relativa ambiente: 75 % Tolleranza: 5 %			Prezzo listino
	Capacità pF	Vn cc	$\varnothing \times L$ mm	
B/76-1	10	500	4 x 10	42
B/76-2	15	500	4 x 10	40
B/76-3	20	500	4 x 10	40
B/76-4	33	500	4 x 10	34
B/76-5	47	500	4 x 10	34
B/76-6	56	500	4 x 10	30
B/76-7	68	500	4 x 10	30
B/77	100	500	4 x 10	30
B/77-1	120	500	4 x 10	30
B/77-2	150	500	4 x 10	30
B/78	200	500	4 x 10	30
B/78-1	330	500	5 x 15	30
B/79	470	500	5 x 15	34
B/79-1	750	500	6 x 20	34
B/79-2	850	500	6 x 20	34
B/79-3	1.000	500	6 x 20	34
B/79-4	1.500	125	6 x 15	40
B/79-5	1.600	125	6 x 15	40
B/79-6	2.200	125	6,5 x 20	40
B/79-7	3.300	125	7 x 20	50
B/80	4.700	125	7 x 20	50
B/80-1	6.800	125	7,5 x 20	60
B/80-2	10.000	125	9 x 20	70
B/80-3	15.000	125	10 x 20	86
B/80-4	22.000	125	11,5 x 30	140
B/80-5	33.000	125	13,5 x 30	162
B/80-6	47.000	125	14,5 x 30	212



Prezzo listino	Condensatori a mica metallizzata Serie 402 con protezione in cera Tensione di lavoro: 500 Vcc Tensione di prova: 1000 Vcc Resist. isolamento a 100 V + 20/°C 80 % di U.R. \geq 7500 M Ω Coefficiente di temperatura: $\pm 100.10^{-6}/^{\circ}\text{C}$ Tolleranza: 5 %						Articolo
	Capacità		Dimensioni in mm				
	pF		A	B	C	D	
40	31 ÷	155	17	10	2,5	0,8	B/81
48	156 ÷	250	17	10	2,5	0,8	B/82
58	251 ÷	300	17	10	2,5	0,8	B/83
58	301 ÷	400	17	10	2,5	0,8	B/83-1
62	401 ÷	500	17	10	2,5	0,8	B/84
76	501 ÷	600	17	10	2,5	0,8	B/85
76	601 ÷	700	17	10	2,5	0,8	B/85-1
80	701 ÷	800	17	10	2,5	0,8	B/85-2
80	801 ÷	900	17	10	2,5	0,8	B/85-3
90	901 ÷	1000	17	10	2,5	0,8	B/85-4
110	1001 ÷	1500	25	10	2,5	0,8	B/86
120	1501 ÷	2000	25	10	2,5	0,8	B/87
150	2001 ÷	3000	37	17	3,5	1,5	B/88
180	3001 ÷	4000	37	17	3,5	1,5	B/89
210	4001 ÷	5000	37	17	3,5	1,5	B/90
260	5001 ÷	6000	37	17	3,5	1,5	B/91
290	6001 ÷	7000	37	17	3,5	1,5	B/92
330	7001 ÷	8000	37	17	3,5	1,5	B/93
360	8001 ÷	9000	37	17	3,5	1,5	B/94
390	9001 ÷	10000	37	17	3,5	1,5	B/95

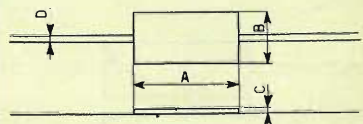

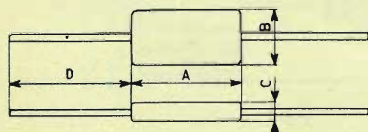

Articolo	Condensatori a mica metallizzata Serie « 420 » in custodia stampata Tensione di lavoro: 500 Vcc Tensione di prova: 1000 Vcc Tolleranza: 5 %					Prezzo listino
	Capacità	Dimensioni in mm				
	pF	A	B	C	D	
B/125	5 ÷ 200	19,8	11,8	5,4	29	80
B/126	201 ÷ 400	19,8	11,8	5,4	29	90
B/127	401 ÷ 600	19,8	11,8	5,4	29	100
B/128	601 ÷ 800	19,8	11,8	5,4	29	120
B/128-1	801 ÷ 1000	19,8	11,8	5,4	29	130
B/129	1001 ÷ 1500	20,5	20,5	6,8	29	200
B/129-1	1501 ÷ 2000	20,5	20,5	6,8	29	220
B/130	2001 ÷ 2500	20,5	20,5	6,8	29	260
B/130-1	2501 ÷ 3000	20,5	20,5	6,8	29	270
B/131	3001 ÷ 3500	20,5	20,5	6,8	29	390
B/131-1	3501 ÷ 4000	20,5	20,5	8,5	29	390
B/131-2	4001 ÷ 4500	20,5	20,5	8,5	29	420
B/131-3	4501 ÷ 5000	20,5	20,5	6,8	29	440
B/132	5001 ÷ 5500	20,5	20,5	6,8	29	590
B/132-1	5501 ÷ 6000	20,5	20,5	6,8	29	620
B/132-2	6001 ÷ 6500	20,5	20,5	6,8	29	640
B/132-3	6501 ÷ 7000	20,5	20,5	6,8	29	660
B/133	7001 ÷ 7500	20,5	20,5	6,8	29	680
B/133-1	7501 ÷ 8000	20,5	20,5	6,8	29	690
B/133-2	8001 ÷ 8500	20,5	20,5	6,8	29	720
B/134	8501 ÷ 9000	20,5	20,5	6,8	29	740
B/134-1	9001 ÷ 9500	20,5	20,5	6,8	29	760
B/134-2	9501 ÷ 10000	20,5	20,5	6,8	29	780

Prezzo listino	Condensatori a mica metallizzata Serie « 422 » in custodia stampata Tensione di lavoro: 500 Vcc Tensione di prova: 1000 Vcc Resist. isolamento a 100 Vcc + 20 °C, 80 % di U.R. ≥ 10.000 MΩ Tolleranza: 5%					Articolo
	Capacità pF	Dimensioni in mm A B C D				
30	31 ÷ 45	13,6	7,2	3,2	30	B/141
34	46 ÷ 80	13,6	7,2	3,2	30	B/141-1
36	81 ÷ 120	13,6	7,2	3,2	30	B/141-2
40	121 ÷ 155	13,6	7,2	3,2	30	B/141-3
40	156 ÷ 185	13,6	7,2	3,2	30	B/142
46	186 ÷ 215	13,6	7,2	3,2	30	B/142-1
48	216 ÷ 250	13,6	7,2	3,2	30	B/142-2
54	251 ÷ 300	19,8	11,8	4	30	B/143
60	301 ÷ 400	19,8	11,8	4	30	B/143-1
68	401 ÷ 500	19,8	11,8	4	30	B/143-2
	Condensatori al mylar « Copo » in poliesteri antiinduttivi con speciale isolamento in materiale plastico Resist. isolamento: 20/°C 100 Vcc > 100.000 MΩ Temperatura ammissibile: — 25 ÷ 85°/C Tolleranza: 20 %					
	Capacità pF	Vn c.c	∅ x L mm			
40	1.000	600	7 x 19		B/160	
40	1.500	600	7 x 19		B/161	
40	2.200	600	7 x 19		B/162	
40	3.300	400	7 x 19		B/165	
40	4.700	400	7 x 19		B/166	
40	6.800	400	7 x 19		B/167	
40	10.000	400	8 x 19		B/168	
40	15.000	400	9 x 19		B/169	
48	22.000	400	9 x 21		B/170	
54	33.000	400	10 x 21		B/171	
60	47.000	400	11 x 21		B/172	
68	68.000	400	10 x 28		B/173	
76	100.000	400	11 x 28		B/174	

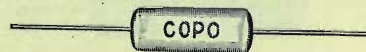
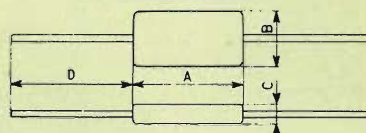



Articolo	Condensatori a carta « Wima - Tropydur » Resist. isolamento: 20.000 MΩ < 0,05 μF Tolleranza: sino a 100 kpF ± 20 % da 0,22 a 470.000 pF ± 10 %			Prezzo listino
	Capacità pF	Vn cc	∅ x L mm	
B/181	1.000	400	6,5 x 9	62
B/182	2.200	400	7,5 x 10,5	62
B/183	3.300	400	7,5 x 11,5	62
B/183-1	4.700	400	8 x 12	62
B/184	10.000	400	8 x 13	70
B/185	15.000	400	7,5 x 12,5	78
B/186	22.000	400	10 x 14	84
B/187	33.000	400	10 x 15	88
B/188	47.000	400	11,5 x 16,5	98
B/189	100.000	400	13 x 18	130
B/190	220.000	400	17 x 23	170
B/191	470.000	400	19 x 27	230



Articolo	Condensatori a carta « Siemens » in custodia di vetro Temperatura di lavoro — 25 ÷ + 60°C Resistenza isolamento: ≥ 10.000 MΩ per C ≤ 0,047 μF ≥ 600 MΩ per C ≥ 0,047 μF Tolleranza: ± 20 %			Prezzo listino
	Capacità pF	Vn cc	∅ x L mm	
B/201	1.000	400	7 x 25	38
B/201-1	2.200	400	7 x 25	38
B/201-2	3.300	400	7 x 25	38
B/202	4.700	400	7 x 25	38
B/202-1	10.000	400	7 x 31	38
B/203	15.000	400	8 x 31	46
B/203-1	22.000	400	9 x 31	56
B/204	33.000	400	11 x 31	64
B/204-1	47.000	400	11 x 35	66
B/205	100.000	400	12 x 45	76
B/206	220.000	400	17 x 45	100
B/207-1	330.000	400	17 x 52	168
B/208	470.000	400	21 x 52	178

Prezzo listino	Condensatori a carta « Icar » custodia isolante iniettata in polixite rossa Resist. isolamento: a 25°C: $\geq 10.000 \text{ M}\Omega$ Temperatura di lavoro: — 30 + 85 °C Tolleranza: $\pm 20 \%$			Articolo
	Capacità pF	Vn cc	$\varnothing \times L$ mm	
250	4.700	1000	6,5 x 16	B/227
260	10.000	1000	10,5 x 21	B/228
270	22.000	1000	12,5 x 26	B/229
296	47.000	1000	14,5 x 31	B/230
340	100.000	1000	18 x 42	B/231
518	150.000	1000	20,5 x 47	B/232
586	220.000	1000	25,5 x 49	B/233
	Condensatori a carta « Facon » in tubetto di vetro Avvolgimento anti-induttivo Temperatura di lavoro: — 20 + 70° C			
	Capacità pF	Vn cc	$\varnothing \times L$ mm	
50	1.000	630	8 x 23	B/241
50	2.200	630	8,5 x 31	B/242
50	3.300	630	8,5 x 31	B/243
50	4.700	630	8,5 x 31	B/244
56	10.000	630	10,5 x 39	B/245
82	22.000	630	10,5 x 39	B/246
100	33.000	630	10,5 x 39	B/246-1
106	47.000	630	13,5 x 39	B/247
166	100.000	630	16 x 50	B/248









Articolo	Condensatori a carta « Facon » in tubetto di vetro Avvolgimento anti-induttivo Temperatura di lavoro: — 20 + 70° C			Prezzo listino
	Capacità pF	Vn cc	∅ x L mm	
B/252	1.000	400	5,5 x 23	36
B/253	2.200	400	8 x 23	36
B/254	3.300	400	8 x 23	36
B/255	4.700	400	8 x 23	36
B/256	10.000	400	8,5 x 31	38
B/257	15.000	400	8,5 x 31	40
B/258	22.000	400	9,5 x 31	44
B/260	33.000	400	9,5 x 31	50
B/261	47.000	400	10,5 x 39	60
B/262	100.000	400	13,5 x 39	70
B/263	220.000	400	16 x 52	110
B/264	470.000	400	22 x 52	180

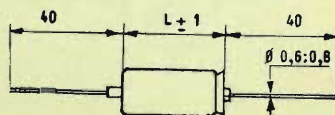

Articolo	Condensatori a carta ed olio « Facon » custodia in bachelite ideali per funzionamento in c.c e in c.a Temperatura di lavoro: — 20 + 75° C			
	Capacità pF	Vn cc	∅ x L mm	
B/271	1.000	1.000	10 x 25	170
B/272	2.200	1.000	10 x 25	170
B/273	3.300	1.000	10 x 25	170
B/274	4.700	1.000	10 x 25	170
B/275	10.000	1.000	10 x 25	200
B/276	15.000	1.000	10 x 25	210
B/277	22.000	1.000	10 x 25	220
B/278	33.000	1.000	11 x 31	230
B/279	47.000	1.000	11 x 31	270
B/280	100.000	1.000	16 x 39	300
B/281	220.000	1.000	19 x 51	480

Prezzo listino	Condensatori elettrolitici miniaturizzati			Articolo
	Capacità μF	Vn cc	$\varnothing \times L$ mm	
240	10	3	5 x 14	B/285
240	30	3	6 x 17	B/286
240	5	6	5 x 14	B/287
240	100	6	6 x 17	B/288
320	3 x 20	10	10 x 14	B/289
240	10	10	6 x 17	B/291
	Condensatori elettrolitici miniatura « Philips »			
	Capacità μF	Vn cc	$\varnothing \times L$ mm	
150	64	10	6,4 x 18	B/295
150	16	10	4,5 x 10	B/296
160	6,4	25	4,5 x 10	B/297
	Condensatori elettrolitici miniatura per circuiti a transistor Temperatura di lavoro da $-20\text{ }^{\circ}\text{C} \div +70\text{ }^{\circ}\text{C}$ Tolleranza di capacità: da $-20\% \div +50\%$			
	Capacità μF	Vn cc	$\varnothing \times L$ mm	
130	2	3	4,5 x 10	B/321
130	5	3	4,5 x 10	B/322
130	10	3	4,5 x 10	B/323
130	25	3	4,5 x 10	B/324
138	50	3	4,5 x 14	B/325
106	100	3	6,5 x 19	B/326
120	200	3	6,5 x 25	B/327

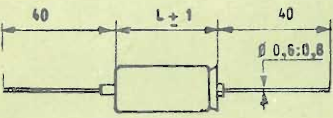

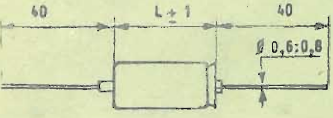
	Articolo	Condensatori elettrolitici miniatura per circuiti a transistor			Prezzo listino
		Capacità	Vn cc	∅ x L	
		μF		mm	
	B/331	2	6	4,5 x 10	130
	B/331-1	5	6	4,5 x 10	130
	B/331-2	10	6	4,5 x 10	130
	B/331-3	25	6	6,5 x 19	106
	B/333	50	6	6,5 x 19	106
	B/334-1	100	6	6,5 x 25	120
	B/335	2	12	4,5 x 10	130
	B/336-1	5	12	4,5 x 10	130
	B/337-1	10	12	4,5 x 14	130
	B/337-2	25	12	6,5 x 19	106
	B/338-1	50	12	6,5 x 19	120
	B/339-1	100	12	8,5 x 19	130
	B/339-2	200	12	8,5 x 30	150
	B/339-3	250	12	10 x 25	180
	B/339-4	2	25	4,5 x 10	130
	B/341-1	5	25	4,5 x 14	138
	B/343	10	25	6,5 x 19	106
	B/345	25	25	6,5 x 19	120
	B/346	50	25	8,5 x 19	126
	B/347	100	25	8,5 x 30	150
	B/348	200	25	10 x 35	180

Prezzo listino	Condensatori elettrolitici catodici « GBC » custodia in tubetto di alluminio			Articolo
	Capacità μF	V_n cc	$\varnothing \times L$ mm	
82	10	25	11 x 22	B/361
98	25	25	11 x 22	B/362
116	50	25	14 x 22	B/363
176	100	25	14 x 32	B/364
250	200	25	14 x 44	B/365
90	5	50	11 x 22	B/371
98	10	50	11 x 22	B/372
116	25	50	14 x 22	B/373
176	50	50	14 x 32	B/374
250	100	50	20 x 36	B/375
278	50	5 c.a.	20 x 34	B/376
	Condensatori elettrolitici catodici con custodia cilindrica di alluminio Temperatura di lavoro da $-20\text{ }^\circ\text{C}$ a $+70\text{ }^\circ\text{C}$ Tolleranza di capacità: da -20% a $+50\%$			
	Capacità μF	V_n cc	$\varnothing \times L$ mm	
112	10	25	12 x 19	B/380
124	25	25	12 x 19	B/381
150	50	25	12 x 19	B/381-1
172	100	25	12 x 29	B/382
230	200	25	14 x 35	B/383
390	500	25	16 x 50	B/384
128	10	50	12 x 19	B/385
140	25	50	12 x 19	B/386
170	50	50	14 x 25	B/387
240	100	50	16 x 30	B/388
320	250	50	16 x 50	B/389
570	500	50	25 x 64	B/390



Articolo	Condensatori elettrolitici catodici di tipo miniaturizzato « Facon » custodia in tubetto di alluminio			Prezzo listino
	Capacità μ F	Vn cc	\varnothing x L mm	
B/404	100	12	10 x 22	148
B/405-1	1000	15	22 x 46	850
B/406	10	25	11 x 22	80
B/407	25	25	11 x 22	120
B/408	50	25	14 x 22	130
B/409	100	25	14 x 32	190
B/410	200	25	14 x 44	280
B/412	10	50	11 x 22	96
B/414	50	50	14 x 32	180
B/415	2	100	11 x 22	98
B/417-1	1	160	20 x 29	320
B/418	8	350	14 x 32	230



Prezzo listino	Condensatori elettrolitici tubolari Tolleranza sulla capacità: — 10 % ÷ + 50 % Temperatura di lavoro: — 20 °C + 55 °C			Articolo
	Capacità μF	Vn cc	$\varnothing \times L$ mm	
168	8	500	18 x 37	B/461
280	16	500	20 x 50	B/462
460	32	500	29 x 50	B/463
300	8 + 8	500	25 x 37	B/464
510	16 + 16	500	29 x 50	B/465
830	25 + 25	500	32 x 64	B/466
166	8	350	16 x 37	B/467
230	16	350	20 x 37	B/468
350	32	350	22 x 50	B/469
470	50	350	25 x 50	B/470
280	8 + 8	350	22 x 37	B/471
395	16 + 16	350	25 x 37	B/472
578	32 + 32	350	25 x 50	B/473
720	40 + 40	350	29 x 50	B/474
790	50 + 50	350	29 x 62	B/475
240	32	250	20 x 52	B/476
390	50	250	20 x 50	B/477
590	100	250	25 x 50	B/478
430	32 + 32	250	25 x 37	B/479
520	40 + 40	250	25 x 50	B/480
580	50 + 50	250	25 x 50	B/481

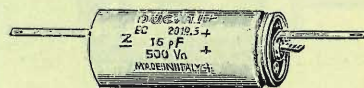



Articolo	Condensatori elettrolitici « GBC » in custodia tubolare di alluminio			Prezzo listino
	Capacità μ F	Vn cc	\varnothing x L mm	
B/501	8	500	20 x 36	148
B/502	8 + 8	500	25 x 45	326
B/502-1	16 + 16	500	35 x 45	530
B/503	16	500	25 x 45	290
B/503-1	32	500	30 x 45	476
B/503-2	40	500	30 x 45	500
B/504	80	500	34 x 82	890
B/505	100	450	34 x 82	960
B/505-1	8	350	20 x 36	150
B/506	8 + 8	350	26 x 36	250
B/507	16	350	26 x 36	226
B/508	20	350	26 x 36	288
B/509	16 + 16	350	26 x 45	370
B/510	32	350	26 x 45	350
B/511	40	350	30 x 45	400
B/512	50	350	30 x 45	460
B/513	32 + 32	350	30 x 45	570
B/514	40 + 40	350	34 x 60	650
B/514-1	50 + 50	350	34 x 60	810
B/514-2	100	350	34 x 60	790
B/515	65 + 65	350	34 x 60	890
B/515-1	80 + 200	350	45 x 99	1050
B/516	100 + 50	350	34 x 80	1050
B/516-1	8	250	14 x 32	130
B/516-2	16	250	20 x 36	210
B/517	32	250	20 x 45	250
B/518	32 + 32	250	26 x 45	390
B/518-1	40 + 40	250	26 x 45	420
B/518-2	50 + 50	250	30 x 45	530
B/518-3	100	250	30 x 45	510
B/518-4	90 + 90	250	30 x 60	880
B/518-6	150 duplic.	200	30 x 45	590
B/522	20	200	26 x 34	220
B/519	50	200	20 x 45	290
B/520	32 + 32	200	26 x 45	290
B/521	40 + 40	200	26 x 34	290

Prezzo listino	Condensatori elettrolitici « Facon » in custodia tubolare di alluminio			Articolo
	Capacità μF	Vn cc	$\varnothing \times L$ mm	
148	8	500	20 x 34	B/551
326	8 + 8	500	26 x 46	B/552
310	16	500	24 x 46	B/553
390	25	500	26 x 46	B/554
550	16 + 16	500	30 x 46	B/555
530	32	500	30 x 46	B/556
850	32 + 32	500	34 x 60	B/556-1
990	40 + 40	500	34 x 80	B/556-2
150	8	350	20 x 34	B/557
298	8 + 8	350	26 x 34	B/558
240	16	350	26 x 34	B/559
370	16 + 16	350	26 x 46	B/560
350	32	350	26 x 46	B/561
490	50	350	30 x 46	B/562
650	32 + 32	350	30 x 46	B/563
890	50 + 50	350	34 x 60	B/564
870	100	350	34 x 60	B/565
210	16	250	20 x 34	B/566
250	25	250	20 x 34	B/567
270	32	250	20 x 46	B/568
390	32 + 32	250	26 x 34	B/569
420	40 + 40	250	26 x 34	B/570
650	50 + 50	250	30 x 46	B/571
630	100	250	30 x 46	B/572
290	32 + 32	200	26 x 26	B/573
290	40 + 40	200	26 x 46	B/574
550	150	200	30 x 46	B/575
600	150 duplic.	200	30 x 46	B/575-1
230	100	50	20 x 34	B/576
390	200	50	26 x 46	B/577



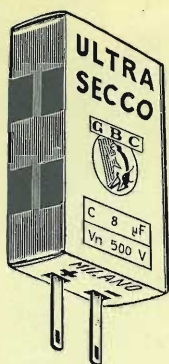

Articolo

Prezzo listino

Condensatori elettrolitici a pacchetto « **G.B.C.** » in custodia di bachelite ricoperta in cartoncino
Tolleranza sulla capacità:
— 10 ÷ + 50 %
Temperatura di lavoro:
— 10 + 70 °C

B/601

Capacità µF Vn cc Dimens. mm

8 500 28 x 14 x 50

156

B/602

16 500 31 x 24 x 50

290



Condensatori elettrolitici a pacchetto « **Facon** » in custodia di bachelite ricoperta in cartoncino
Tolleranza sulla capacità:
— 10 ÷ + 50 %
Temperatura di lavoro:
— 10 + 70 °C

B/621

Capacità µF Vn cc Dimens. mm

8 500 28 x 14 x 50

154

B/622

8 + 8 500 28 x 28 x 50

320

B/623

16 500 31 x 24 x 50

330

B/624

16 350 28 x 14 x 50

260

B/625

32 350 31 x 24 x 50

360

B/626

32 250 28 x 14 x 50

320

B/627

60 + 20 150 38 x 15 x 50

540

B/628

80 + 30 130 38 x 15 x 50

580

B/629

8 750 28 x 28 x 50

750

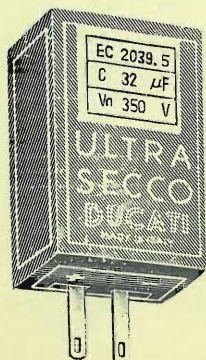

Condensatori elettrolitici a pacchetto in custodia di bachelite ricoperta in cartoncino
Tolleranza sulla capacità:
— 10 % ÷ + 50 %

B/641

Capacità µF Vn c.c. Dimens. mm

8 500 30 x 14 x 47

164

B/642

16 500 30 x 22 x 47

280

B/643

16 350 30 x 14 x 47

260

B/644

32 350 30 x 14 x 47



370



Prezzo listino	Condensatori elettrolitici a vitone « Facon » Tolleranza sulla capacità: — 10 ÷ + 50 %			Articolo
	Capacità μF	Vn cc	$\varnothing \times L$ mm	
250	8	500	24 x 38	B/661
440	8 + 8	500	24 x 50	B/662
490	8 + 8 + 8	500	37 x 50	B/662-1
440	16	500	24 x 50	B/663
650	16 + 16	500	24 x 88	B/664
630	32	500	24 x 88	B/665
950	32 + 32	500	30 x 88	B/666
1000	40 + 40	500	37 x 88	B/667
1000	80	500	37 x 88	B/668
230	8	350	24 x 38	B/669
350	8 + 8	350	24 x 38	B/670
330	16	350	24 x 38	B/671
510	16 + 16	350	24 x 50	B/672
490	32	350	24 x 50	B/673
500	40	350	24 x 50	B/673-1
750	32 + 32	350	24 x 88	B/674
950	50 + 50	350	30 x 88	B/675
930	100	350	30 x 88	B/676
1130	150 + 50 + 16	350	37 x 88	B/676-1
500	50	250	24 x 50	B/677
580	32 + 32	250	24 x 50	B/678
680	40 + 40	250	24 x 88	B/679
720	50 + 50	250	24 x 88	B/680
590	150 duplic.	200	30 x 50	B/685
	Condensatori elettrolitici « Facon » per telefonia - tipi a vitone Tolleranza sulla capacità: — 10 ÷ + 50 %			
	Capacità μF	Vn cc	$\varnothing \times L$ mm	
750	500	15	24 x 50	B/691
950	500 + 500	15	30 x 50	B/692
950	1000	15	30 x 50	B/693
950	500	50	30 x 50	B/694
1250	500 + 500	40	30 x 88	B/695



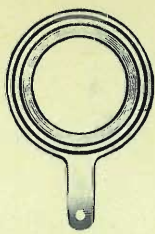

Articolo	Capacità μF	Vn c.c.	$\varnothing \times L$ mm	Prezzo listino
Condensatori elettrolitici a vitone « G.B.C. » Tolleranza sulla capacità: — 10 % \div + 50 % Temperatura di lavoro: —10 + 70° C				
B/696	8	500	25 x 40	240
B/696-1	8 + 8	500	25 x 50	430
B/697	16 + 16	500	25 x 85	640
B/698	32	500	25 x 85	610
B/698-1	32 + 32	500	30 x 85	900
B/699	40 + 40	500	35 x 85	970
B/701	80	500	35 x 85	970
B/701-1	8 + 8	350	25 x 10	350
B/701-2	16	350	25 x 40	320
B/701-3	16 + 16	350	25 x 50	500
B/701-4	32	350	25 x 50	480
B/701-5	32 + 32	350	25 x 85	720
B/702	50 + 50	350	30 x 85	900
B/702-1	32 + 32	250	25 x 50	560
B/703	50 + 50	250	25 x 85	690

Prezzo listino				Articolo	
	Rondella metallica per condensatori elettrolitici a vitone				
10	∅ esterno mm 26 - ∅ interno mm 16			B/711	
10	∅ esterno mm 31 - ∅ interno mm 17			B/712	
	Rondella isolante per condensatori elettrolitici a vitone				
10	∅ esterno mm 26 - ∅ interno mm 15,5			B/715	
10	∅ esterno mm 31 - ∅ interno mm 16			B/716	
	Condensatori elettrolitici con fissaggio a vitone Tolleranza sulla capacità: — 10 % ÷ + 50 % Temperatura di lavoro: — 20 °C + 55 °C				
	Capacità µF	Vn cc	∅ x L mm		
330	32	250	20 x 40	B/721	
620	40 + 40	250	25 x 62	B/722	
720	50 + 50	250	32 x 69	B/723	
430	32	350	22 x 53	B/724	
650	50	350	25 x 56	B/725	
820	32 + 32	350	25 x 62	B/726	
880	40 + 40	350	29 x 62	B/727	
1040	50 + 50	350	29 x 72	B/728	
250	8	500	20 x 40	B/729	
370	16	500	20 x 53	B/730	
570	32	500	29 x 56	B/731	
950	80	500	36 x 68	B/732	
420	8 + 8	500	25 x 47	B/733	
620	16 + 16	500	29 x 60	B/734	
940	32 + 32	500	29 x 100	B/735	
1150	40 + 40	500	36 x 72	B/736	
1250	50 + 50	500	36 x 100	B/737	

Articolo	Condensatori elettrolitici a vitone « Philips »			Prezzo listino
	Capacità μF	Vn cc	$\varnothing \times L$ mm	
 B/751	50 + 50	250	30 x 80	660
B/751-1	16 + 16	300	30 x 80	590
B/751-2	25 + 25	300	30 x 80	690
B/751-3	32 + 32	300	30 x 80	740
B/751-4	50 + 50	300	30 x 80	850
B/754	32	350	30 x 80	490
B/755	50 + 50	350	30 x 80	740
B/756	16 + 16	350	30 x 80	650
B/757	25 + 25	350	30 x 80	630
B/758	32 + 32	350	30 x 80	790
B/759	64 + 64	350	30 x 80	990
B/752	16	450	30 x 80	490
B/768	32 + 32	450	30 x 80	850
 B/761	100 + 100	250	30 x 80	1050
B/762	100 + 100 + 50	300	30 x 80	1150
 B/771	4	500	45 x 75	1200
B/772	8	500	45 x 120	1750
B/773	12	500	60 x 120	2700

Prezzo listino				Articolo
	Condensatori « Facon » in carta ed olio, adatti per rifasamento di lampade fluorescenti e per avviamento di motori monofasi ad induzione Tolleranza sulla capacità, a 20 °C, 50 Hz: — 5 + 10 % Resist. isolamento a 100 Vcc: $\geq 3.000 \text{ M}\Omega \times \mu\text{F}$			
	Capacità μF	Vn ca	$\varnothing \times L$ mm	
750	2	260	40 x 65	B/781
790	4	260	45 x 75	B/782
1150	6	260	50 x 75	B/783
1250	7	260	40 x 120	B/784
1300	8	260	45 x 120	B/785
1850	10	260	45 x 120	B/786
2250	12	260	50 x 120	B/787
2450	16	260	60 x 120	B/788
950	2	400	40 x 65	B/789
1550	4	400	50 x 75	B/790
2100	6	400	45 x 120	B/791
2700	8	400	50 x 120	B/792
2900	10	400	60 x 120	B/793
	Condensatori « Facon » in carta ed olio, adatti per stabilizzatori di tensione			
	Capacità μF	Vn ca	$\varnothing \times L$ mm	
1980	4	600	50 x 120	B/801
2480	5	600	50 x 120	B/802
2980	6	600	60 x 120	B/803
3240	7	600	60 x 120	B/804
3500	8	600	60 x 120	B/805
	Condensatori « Facon » elettrolitici in custodia cilindrica			
	Capacità μF	Vn cc	$\varnothing \times L$ mm	
900	80	500	37 x 100	B/811
890	100	350	37 x 50	B/812





Articolo				Prezzo listino
	Condensatori a carta e olio per telefonia ed elettronica Tolleranza: $\pm 10\%$ Temperatura di lavoro: da $-55\text{ }^{\circ}\text{C}$ \div $+85\text{ }^{\circ}\text{C}$			
	Capacità μF	Vn cc	$\varnothing \times L$ mm	
B/821	1,6	500 V	20 x 35	1150
B/822	2,5	500 V	20 x 53	1350
B/823	0,5	750 V	12 x 53	850
B/824	1	750 V	12 x 53	950
B/825	2	750 V	20 x 53	1150
B/826	0,5	1000 V	12 x 35	950
B/827	1	1000 V	20 x 35	1000
B/828	1,6	1000 V	30 x 53	1200
B/829	0,5	2000 V	20 x 35	1100
B/830	1	2000 V	20 x 53	1300

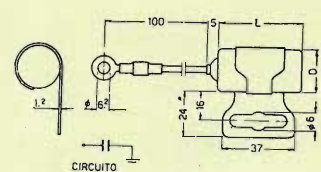
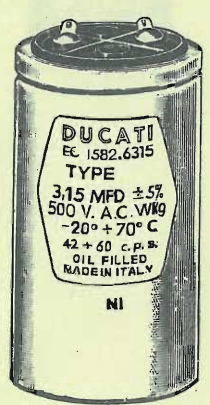

	Condensatori tubolari in carta e olio per uso universale Tolleranza: $\pm 10\%$ Temperatura di lavoro: da $55\text{ }^{\circ}\text{C}$ \div $+85\text{ }^{\circ}\text{C}$			
	Capacità μF	Vn cc	$\varnothing \times L$ mm	
B/861	8	500	40 x 112	2150
B/862	10	500	45 x 112	2550
B/863	16	500	55 x 112	3350
B/864	20	500	60 x 112	3980
B/865	2	1000	36 x 64	1400
B/866	5	1000	40 x 112	2000
B/867	8	1000	55 x 112	2500
B/868	10	1000	60 x 112	3100
B/869	0,5	3000	40 x 64	1350
B/870	1	3000	40 x 112	1650

Prezzo listino 590	<p>Condensatori « Icar » antidisturbo per auto Tolleranza: $\pm 10\%$ Resist. isolamento: $> 5000 \text{ M}\Omega \mu\text{F}$</p> <p>Capacità: $0,5 \mu\text{F}$ Tensione di lavoro: 500 Vcc Dimensioni: mm $22,5 \times 40$</p>	Articolo B/871	 <p>The drawing shows a cylindrical capacitor with a terminal on the left. Dimensions are labeled: 100 (total length), 5 (terminal length), L (main body length), 10 (main body diameter), 12 (terminal diameter), 16 (terminal diameter), 20 (main body diameter), 18 (main body diameter), 37 (main body diameter), and 16 (main body diameter). A circuit diagram below shows the capacitor connected to a terminal labeled 'CIRCUITO'.</p>																											
740	<p>Capacità: $1 \mu\text{F}$ Tensione di lavoro: 500 Vcc Dimensioni: mm 26×50</p>	B/872																												
1250 1450 1750 2200 2300 2500 3200 3700	<p>Condensatori per applicazioni varie in circuiti a corrente alternata. Serie realizzata per tutte le applicazioni in c.a. ove non si superi la tensione max. permanente di lavoro di 560 V.</p> <table border="1" data-bbox="197 1021 616 1612"> <thead> <tr> <th>Capacità μF</th> <th>VI</th> <th>$\varnothing \times L$ mm</th> </tr> </thead> <tbody> <tr> <td>3,15</td> <td>600</td> <td>45 x 102</td> </tr> <tr> <td>4</td> <td>600</td> <td>50 x 102</td> </tr> <tr> <td>5</td> <td>600</td> <td>50 x 120</td> </tr> <tr> <td>6,3</td> <td>600</td> <td>55 x 110</td> </tr> <tr> <td>7</td> <td>600</td> <td>50 x 112</td> </tr> <tr> <td>8</td> <td>600</td> <td>60 x 110</td> </tr> <tr> <td>10</td> <td>600</td> <td>60 x 130</td> </tr> <tr> <td>12,5</td> <td>600</td> <td>65 x 130</td> </tr> </tbody> </table>	Capacità μF	VI	$\varnothing \times L$ mm	3,15	600	45 x 102	4	600	50 x 102	5	600	50 x 120	6,3	600	55 x 110	7	600	50 x 112	8	600	60 x 110	10	600	60 x 130	12,5	600	65 x 130	B/880 B/881 B/882 B/883 B/884 B/885 B/886 B/887	 <p>The image shows a cylindrical capacitor with a label that reads: DUCATI, EC 1582.6315, TYPE, 3,15 MFD $\pm 5\%$, 500 V. A.C. WVG, $-20^\circ + 70^\circ \text{ C}$, 42 + 60 c.p.s., OIL FILLED, MADE IN ITALY, NI.</p>
Capacità μF	VI	$\varnothing \times L$ mm																												
3,15	600	45 x 102																												
4	600	50 x 102																												
5	600	50 x 120																												
6,3	600	55 x 110																												
7	600	50 x 112																												
8	600	60 x 110																												
10	600	60 x 130																												
12,5	600	65 x 130																												





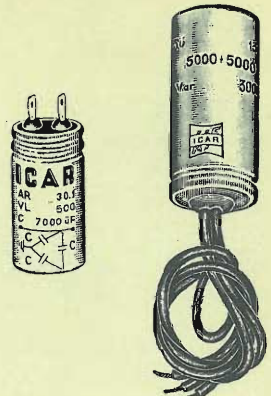
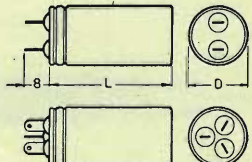
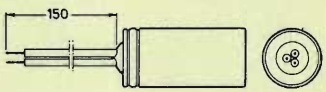
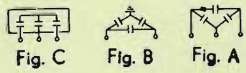
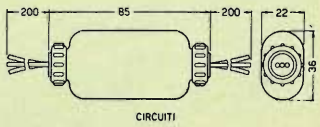
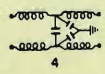











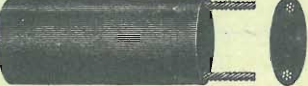
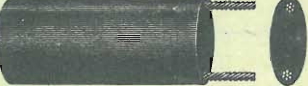

Articolo	Condensatori elettrolitici « Facon » per avviamento di motori monofase ad induzione			Prezzo listino
	Capacità µF	VI ca	∅ x L mm	
B/901	75	125	37 x 60	1500
B/902	100	125	37 x 60	1600
B/903	140	125	37 x 100	1900
B/904	160	125	37 x 100	2200
B/905	200	125	37 x 100	2600
B/906	250	125	45 x 100	2900
B/907	300	125	45 x 100	3600
B/908	75	160	37 x 60	1600
B/909	100	160	37 x 100	1700
B/910	140	160	37 x 100	2200
B/911	160	160	37 x 100	2500
B/912	200	160	45 x 100	2800
B/913	250	160	45 x 100	3500
B/914	315	160	50 x 100	4600
B/915	30	220	37 x 60	1500
B/916	80	220	37 x 100	2200
B/917	100	220	45 x 100	2500
B/918	140	220	45 x 100	3100
B/919	160	220	45 x 100	3500
B/920	200	220	50 x 100	4200
B/921	250	220	50 x 100	4600



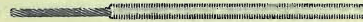

Prezzo listino		Articolo																
490	<p>Condensatori « Icar » di filtro, spegni scintilla, silenziamento, dispositivi eliminadisturbi Tolleranza: $\pm 10\%$ Resist. isolamento: $\geq 5000\text{ M}\Omega$ Limite di temperatura: $-20 + 85\text{ }^\circ\text{C}$</p> <p>Condensatore triplo Capacità: pF 7000 x 3 Tensione di lavoro: 500 V Dimensioni: mm $\varnothing 16 \times 32$ Circuiti: fig. B</p>	B/951																
640	<p>Condensatore triplo Capacità: pF 50.000 + 50.000 + 5.000 Tensione di lavoro: 350 V Dimensioni: mm $\varnothing 16 \times 32$ Circuiti: fig. C</p>	B/952																
1080	<p>Condensatore triplo Capacità: pF 5.000 + 5.000 + 50.000 Tensione di lavoro: 350 V Dimensioni: mm $\varnothing 16 \times 32$ Circuiti: fig. A</p>	B/953																
1080	<p>Condensatore triplo Capacità: pF 2.500 + 2.500 + 50.000 Tensione di lavoro: 350 V Dimensioni: mm $\varnothing 16 \times 32$ Circuiti: fig. A</p>	B/954																
1080	<p>Condensatore triplo Capacità: pF 25.000 + 25.000 + 25.000 Tensione di lavoro: 350 V Dimensioni: mm $\varnothing 16 \times 32$ Circuiti: fig. A</p>	B/955	<p style="text-align: center;">Circuiti interni</p> 															
3900	<p>Dispositivi anti disturbo « Icar » in custodia di materiale plastico Corrente max: 2 A Tensione: 42 ÷ 60 Hz</p> <table border="0" style="width: 100%;"> <tr> <td style="text-align: center;">Capacità</td> <td style="text-align: center;">Tens.</td> <td></td> </tr> <tr> <td style="text-align: center;">pF</td> <td style="text-align: center;">V.</td> <td></td> </tr> <tr> <td>5.000 + 5.000 + 50.000</td> <td>300</td> <td>B/961</td> </tr> <tr> <td>2.500 + 2.500 + 50.000</td> <td>300</td> <td>B/962</td> </tr> <tr> <td>25.000 + 25.000 + 25.000</td> <td>300</td> <td>B/963</td> </tr> </table>	Capacità	Tens.		pF	V.		5.000 + 5.000 + 50.000	300	B/961	2.500 + 2.500 + 50.000	300	B/962	25.000 + 25.000 + 25.000	300	B/963		 
Capacità	Tens.																	
pF	V.																	
5.000 + 5.000 + 50.000	300	B/961																
2.500 + 2.500 + 50.000	300	B/962																
25.000 + 25.000 + 25.000	300	B/963																

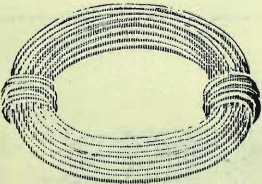

Articolo	<p align="center">CAVI COASSIALI SCHERMATI ISOLATI IN POLIETILENE PER DISCESE D'ANTENNA TV</p> <p>Tutti i nostri conduttori si distinguono dalla concorrenza per la qualità della materia prima impiegata, direttamente, importata, di cui garantiamo l'assoluta stabilità nel tempo e di isolamento. Le nostre piattine TV sono marcate ogni cm. 60 e quindi non soggette ad essere facilmente contraffatte. I prezzi si intendono per matasse da 100 metri. Per quantitativi inferiori aumento 20 %.</p>	Prezzo listino
C/3	Cavo coassiale 62 Ohm - schermatura in rame rosso - tipo normale Ø esterno mm 6	70
C/8	Cavo coassiale 75 Ω tipo C schermatura in rame rosso Ø esterno mm 6	64
C/9	Cavo coassiale 62/75 Ω tipo CC economico - schermatura in rame rosso Ø esterno mm 5	58
C/10	Cavo coassiale 75 Ohm - schermatura in rame rosso - tipo extra Ø esterno mm 6	78
C/11	Cavo coassiale 75 Ohm - schermatura in rame stagnato - tipo extra Ø esterno mm 6	88
C/12	Cavo coassiale 62 Ω « Isocel » Ø esterno mm 5,5	88
C/13	Cavo coassiale 75 Ω « Isocel » Ø esterno mm 5,5	82
C/14	Cavo coassiale 75 Ω « Isocel » Ø esterno mm 5,8	94
C/16	Cavo coassiale 51 ohm Con forte schermatura, esecuzione speciale a bassa attenuazione per impianti UHF (2° canale) Ø mm 8	360
C/17	Cavo coassiale 75 ohm con forte schermatura e nastro antimigrante - per impianti UHF (2° canale) Ø esterno: mm 6,7 Sezione: mmq 1 Formazione: 1 x 11,5/10	140
C/18	Cavo coassiale schermato 75 ohm per impianti UHF (2° canale) Ø esterno: mm 6,30 circa Sezione: mmq 0,80	98





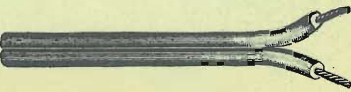

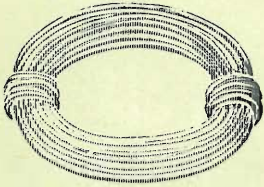

Prezzo listino		Articolo	
22	PIATTINE TV Piattina TV - 300 Ohm isol. rinforzato in polietilene 2 x 0,35	C/51	
28	Piattina TV - 300 Ohm isol. rinforzato in polietilene 2 x 0,35	C/52	
36	Piattina TV - 300 Ohm isol. rinforzato in polietilene 2 x 0,50	C/53	
56	Piattina TV - 300 Ohm isol. super extra in polietilene 2 x 0,50	C/61	
150	Piattina TV - 300 Ohm - Tipo RAI isol. in polietilene per grandi distanze 2 x 1,37	C/71	
38	Piattina TV - 300 Ohm isol. « Antiox » rinforzato 2 x 0,50	C/83	
60	Piattina TV - 300 Ohm isol. « Antiox » super extra 2 x 0,50	C/91	
166	Piattina TV - 300 Ohm isol. « Antiox » - grandi distanze 2 x 1,37	C/95	
170	Piattina bifilare TV - 300 ohm « Isocel » Dimensioni esterne mm. 13 x 8	C/96	
42	Piattina TV - 300 Ohm guaina in cloruro di polivinile colore grigio 2 x 0,35	C/98	
56	Piattina TV - 300 Ohm guaina in cloruro di polivinile colore grigio 2 x 0,50	C/99	

	Articolo		Prezzo Ilistino
	C/101	Cavetto schermato; calza cotone e rame stagnato - Sez.: 1 x 0,35	46
	C/102	Cavetto schermato; elica cellophan e calza rame stagnato - Sez.: 1 x 0,35	56
	C/103	Cavetto per microfono schermato; rivestimento vipla - Sez.: 1 x 0,50	100
	C/104	Cavetto per microfono, schermato rivestimento vipla - Sez.: 2 x 0,50	146
	C/105	Cavetto per microfono, schermato in rame stagnato ricoperto in vipla color avorio - Sez.: mmq 0,125	50
	C/106	Cavetto per microfono, schermato in rame stagnato, ricoperto in vipla color nero - Sez.: mmq 0,125	50
	C/107	Cavetto schermato Spiralatura lamellare - Sez.: 1 x 0,35	84
	C/108	Cavetto schermato unipolare per pick-up e microfono, ricoperto in vipla, color avorio Ø esterno: mm 1,6	160
	C/109	Cavetto schermato bifilare per microfono e pick-up stereofonici, ricoperto in vipla, color avorio Ø esterno: mm 2	86
	C/111	Cavetto isolato in politene a 6000 Volt Sez.: 0,50	46
	C/112	Cavetto isolato in politene a 20000 Volt Sez.: 0,50	58
	C/121	Filo push-back per connessioni, rame stagnato Ø 8/10 isolato con 2 spirali di cotone; nastro carta e calza cotone paraffinato	24
	C/129-1	Busta filo push-back ricoperto in vipla Ø 5/10 da mt 5 Colori assortiti	100
C/129-2	Busta filo push-back ricoperto in vipla Ø 5/10 da mt 10 Colori assortiti	164	
C/130-1	Busta filo push-back ricoperto in vipla Ø 6/10 da mt 5 Colori assortiti	120	
C/130-2	Busta filo push-back ricoperto in vipla Ø 6/10 da mt 10 Colori assortiti	174	

Prezzo listino		Articolo	
14	Filo push-back - rame stagnato, ricoperto in vipla Ø 6/10	C/130	
12	Filo push-back - rame stagnato, ricoperto in vipla Ø 7/10	C/131	
14	Filo push-back - rame stagnato, ricoperto in vipla Ø 8/10	C/132	
28	Filo push-back isolato in Althene Ø 8/10 - monocoloro	C/136	
38	Filo push-back isolato in Althene Ø 8/10 - bicolore	C/136-1	
264	Cavetto unipolare a forte schermatura, ricopertura in plastica. Capacità ca. 200 pF/m Ø ca. 2 mm	C/141	
408	Cavetto unipolare a forte schermatura, ricopertura in plastica. Capacità ca. 60 pF/m - Ø ca. 4 mm	C/142	
418	Cavetto unipolare, forte schermo, con ricopertura in plastica, Capacità ca. 100 pF/m - Ø ca. 2,6 mm	C/143	
506	Cavetto bipolare, forte schermatura ricopertura in plastica Capacità 90 pF/m - Ø ca. 4 mm	C/144	
2400	Filo rame stagnato nudo Ø 7/10 al kg	C/151	
2400	Filo rame stagnato nudo Ø 8/10 al kg	C/152	
2400	Filo rame stagnato nudo Ø 10/10 al kg	C/153	
18	Piattina vipla - Costa stretta Sez. 2 x 0,35	C/171	
26	Piattina vipla - Costa stretta Sez. 2 x 0,50	C/172	
18	Piattina vipla - Costa larga Sez. 2 x 0,35	C/173	
26	Piattina vipla - Costa larga Sez. 2 x 0,50	C/174	
34	Piattina flessibilissima extra-lusso Sez. 2 x 0,35	C/181	
48	Piattina flessibilissima extra-lusso Sez. 2 x 0,50	C/182	

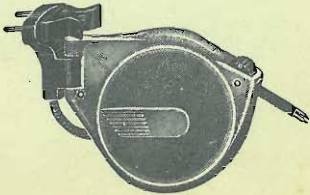
	Articolo		Prezzo listino
	C/191	Trecciola ricoperta in vipla Sez.: mmq 0,12 Ø esterno: mm 1	4
	C/192	Trecciola ricoperta in vipla Sez.: mmq 0,15 Ø esterno: mm 1	6
	C/193	Trecciola ricoperta in vipla Sez.: mmq 0,25 Ø esterno: mm 1,2	8
	C/194	Trecciola ricoperta in vipla Sez.: mmq 0,35 Ø esterno: mm 2	10
	C/195	Trecciola ricoperta in vipla Sez.: mmq 0,50 Ø esterno: mm 2	14
	C/196	Buste di trecciola ricoperta in vipla Sez.: mmq 0,12 - da mt 10 Colori assortiti	144
	C/197	Buste di trecciola ricoperta in vipla Sez.: mmq 0,15 - da mt 10 Colori assortiti	156
	C/198	Buste di trecciola ricoperta in vipla Sez.: mmq 0,25 da mt 10 Colori assortiti	180
	C/199	Buste di trecciola ricoperta in vipla Sez.: mmq 0,35 da mt 10 Colori assortiti	206
	C/200	Buste di trecciola ricoperta in vipla Sez.: mmq 0,50 da mt 10 Colori assortiti	230
	C/201	Cordone in vipla a 2 conduttori Sez.: mmq 0,35	33
	C/202	Cordone in vipla a 3 conduttori Sez.: mmq 0,35	44
	C/203	Cordone in vipla a 4 conduttori Sez.: mmq 0,35	52
	C/204	Cordone in vipla a 5 conduttori Sez.: mmq 0,35	74
	C/205	Cordone in vipla a 6 conduttori Sez.: mmq 0,35	94

Prezzo listino		Articolo	
	Cordone in vipla completo di spina da 6 Amp. Lunghezza mt. 1,50		
120	Colore avorio - sez. mmq. 0,35	C/221	
120	» marrone - sez. mmq. 0,35	C/222	
120	» nero - sez. mmq. 0,35	C/222-1	
150	» avorio - sez. mmq. 0,50	C/223	
150	» marrone - sez. mmq. 0,50	C/224	
150	» nero - sez. mmq. 0,50	C/225	
	Cordone in vipla completo di spina e presa da 6 Amp. Lunghezza mt. 2		
210	Colore avorio - sez. mmq. 0,35	C/231	
210	» marrone - sez. mmq. 0,35	C/232	
210	» nero - sez. mmq. 0,35	C/232-1	
250	» avorio - sez. mmq. 0,50	C/233	
250	» marrone - sez. mmq. 0,50	C/234	
250	» nero - sez. mmq. 0,50	C/235	
	Cordone in vipla completo di due spine da 6 Amp. Lunghezza mt 2		
210	Colore avorio - sez. mmq. 0,35	C/251	
210	» marrone - sez. mmq. 0,35	C/252	
210	» nero - sez. mmq. 0,35	C/252-1	
250	» avorio - sez. mmq. 0,50	C/253	
250	» marrone - sez. mmq. 0,50	C/254	
250	» nero - sez. mmq. 0,50	C/255	
290	Cordone d'alimentazione color avorio, con presa speciale - fori mm 3 Interasse mm 13 - spina 6 Amp. Sez. 2 x 0,75 - lunghezza mt 1,5	C/260	
290	Cordone d'alimentazione color marrone, con presa speciale - fori mm 3 Interasse mm 13 - spina 6 Amp. Sez. 2 x 0,75 - lunghezza mt 1,5	C/262	
2950	Riavvolgitore automatico per collegamenti volanti - adatto per rasoi elettrici, accendigas, ecc. - comprende una spina bipolare con dispositivo antistrappo e mt. 2,20 di cavetto m/mq. 2 x 0,75, racchiuso in custodia di plastica avorio Ingombro: mm 145 x 125 x 35	C/281	

	Articolo	Prezzo listino
	C/301 Tubetto vipla \varnothing mm 1	8
	C/302 Tubetto vipla \varnothing mm 1,5	10
	C/303 Tubetto vipla \varnothing mm 2	12
	C/304 Tubetto vipla \varnothing mm 2,5	14
	C/305 Tubetto vipla \varnothing mm 3	16
	C/306 Tubetto vipla \varnothing mm 4	20
	C/307 Tubetto vipla \varnothing mm 5	22
	C/308 Tubetto vipla \varnothing mm 6	32
	C/309 Tubetto vipla \varnothing mm 7	40
	C/310 Tubetto vipla \varnothing mm 8	44
	C/311 Tubetto vipla \varnothing mm 9	48
	C/312 Tubetto vipla \varnothing mm 10	60
	C/351 Tubetto sterlingato \varnothing mm 0,5	32
	C/352 Tubetto sterlingato \varnothing mm 1	36
	C/353 Tubetto sterlingato \varnothing mm 1,5	42
	C/354 Tubetto sterlingato \varnothing mm 2	48
	C/355 Tubetto sterlingato \varnothing mm 2,5	52
	C/356 Tubetto sterlingato \varnothing mm 3	60
	C/357 Tubetto sterlingato \varnothing mm 4	70
	C/358 Tubetto sterlingato \varnothing mm 5	80
	C/358-1 Tubetto sterlingato \varnothing mm 6	94
	C/358-2 Tubetto sterlingato \varnothing mm 7	108
	C/358-3 Tubetto sterlingato \varnothing mm 8	128
	C/358-4 Tubetto sterlingato \varnothing mm 9	144
	C/359 Tubetto sterlingato \varnothing mm 10	170
	C/360 Tubetto di seta \varnothing mm 0,8	72

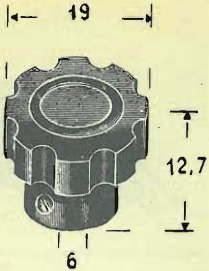
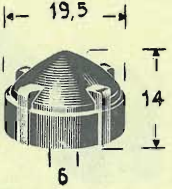
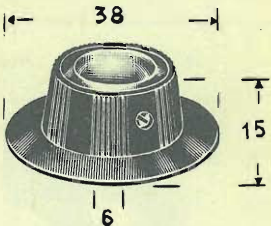
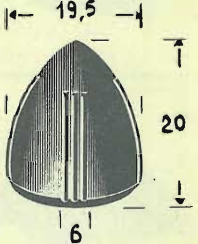
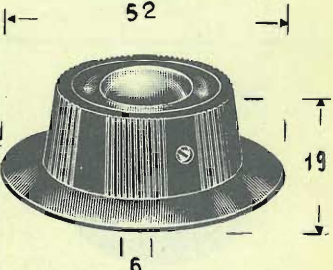
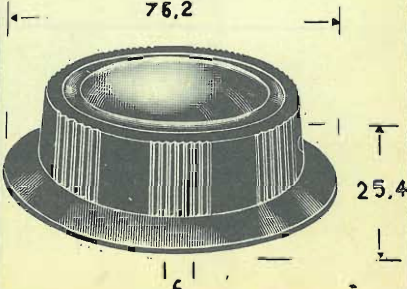
<p>Prezzo listino</p> <p>150</p>	<p>Manopola con impugnatura scanalata in bachelite nera K 111</p>	<p>Articolo</p> <p>F/1</p>	
<p>136</p>	<p>Manopola in bachelite nera K 324</p>	<p>F/2</p>	
<p>230</p>	<p>Manopola per strumenti in bachelite nera K 360</p>	<p>F/4</p>	
<p>150</p>	<p>Manopola a « cuore » in bachelite nera K 133</p>	<p>F/5</p>	
<p>380</p>	<p>Manopola per strumenti in bachelite nera K 361</p>	<p>F/6</p>	
<p>780</p>	<p>Manopola per strumenti in bachelite nera K 362</p>	<p>F/7</p>	

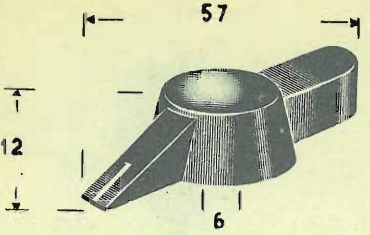
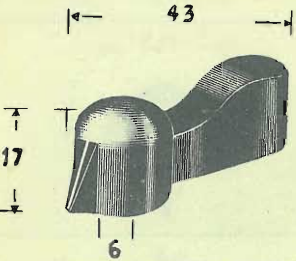
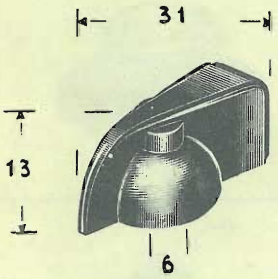
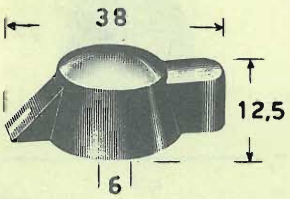
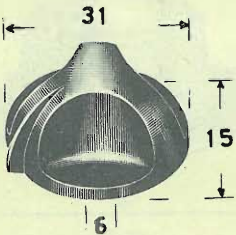
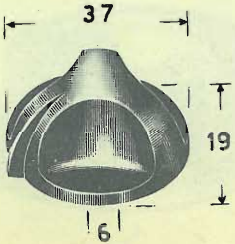
	Articolo		Prezzo listino
	F/12	Manopola a indice in bachelite nera K 60	230
	F/13	Manopola a indice in bachelite nera K 390	200
	F/14	Manopola a indice in bachelite nera K 107	140
	F/15	Manopola a indice in bachelite nera K 357	140
	F/16	Manopola a indice in polistirene termoplastico nera K 58	190
	F/17	Manopola a indice in bachelite nera K 344/P	160
	F/18	Manopola a indice in bachelite nera K 345/P	160

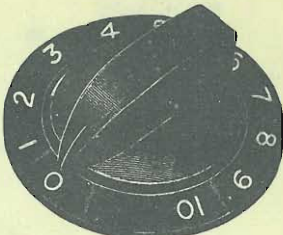
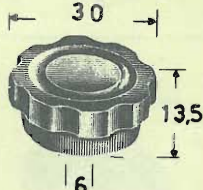
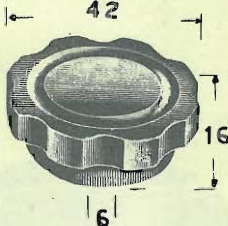
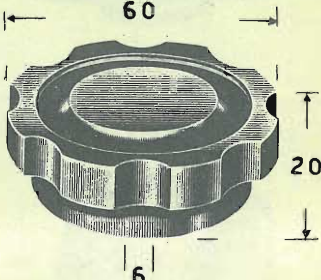
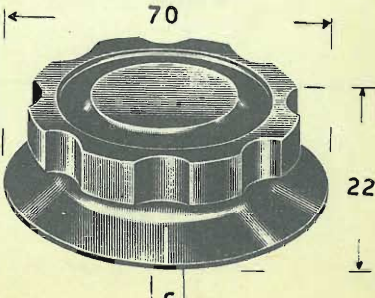
Prezzo listino		Articolo	
240	Manopola a indice per strumenti in bachelite nera lungh. max: mm 36 altezza: mm 15 foro: \varnothing 6 K 370	F/19	
136 240 240 240	Piattelli per manopola F/19 in bachelite nera \varnothing mm 48 Piattello non graduato Piattello graduato 0 ÷ 10 su 250° Piattello graduato 0 ÷ 10 su 180° Piattello graduato 0 ÷ 18 su 360°	F/20 F/21 F/22 F/23	
76	Manopola per strumenti in bachelite nera	F/31	
200	Manopola per strumenti in bachelite nera	F/32	
300	Manopola per strumenti in bachelite nera	F/33	
330	Manopola per strumenti in bachelite nera	F/34	

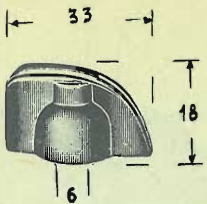
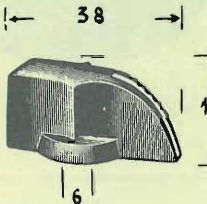
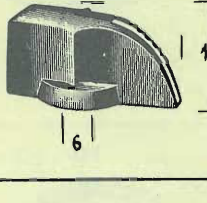
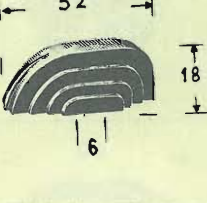
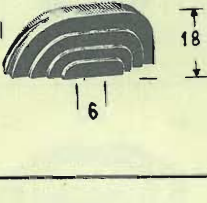
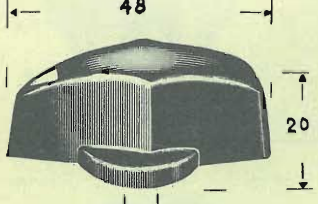
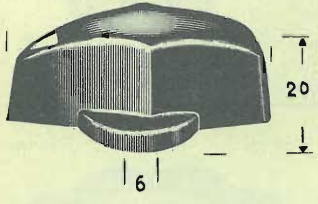
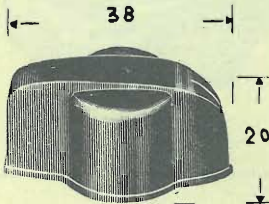
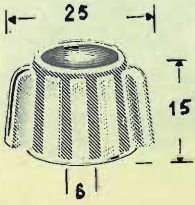
	Articolo		Prezzo listino
	F/35	Manopola a indice in urea color avorio	66
	F/36	Manopola a indice in bachelite nera	60
	F/37	Manopola a indice in urea color avorio	72
	F/38	Manopola a indice in bachelite nera	62
	F/39	Manopola a indice in urea color avorio	90
	F/40	Manopola a indice in bachelite nera	90
	F/43	Manopola a indice in bachelite nera 10534	218
	F/44	Manopola a indice in bachelite nera 20108	184
	F/45	Manopola a indice in bachelite color grigio-disco in metallo color argento - 10742	200

Prezzo listino		Articolo	
130	Manopola a indice in urea color avorio 20109	F/51	
130	Manopola a indice in bachelite nera 20109	F/51-1	
120	Manopola a indice in bachelite nera 10530	F/52	
82	Manopola a indice in urea color avorio, con bussola di metallo annegata 2769/RK	F/53-1	
82	Manopola a indice in bachelite nera con bussola di metallo annegata 2769/RK	F/53-2	
200	Manopola a indice in bachelite nera 2768/RK	F/54	
346	Manopola a indice in bachelite nera 10535	F/55	
130	Manopola a indice in bachelite nera 10532	F/56	

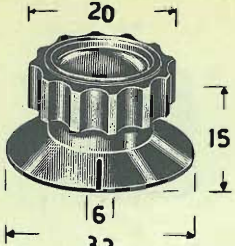
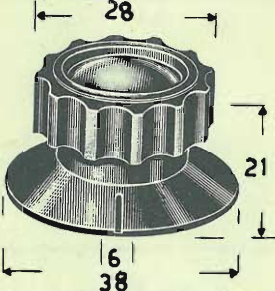
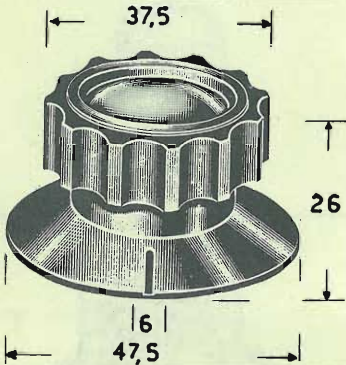
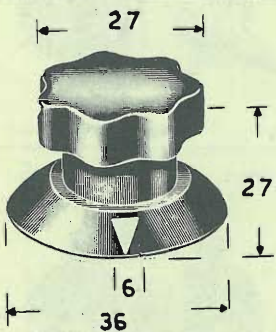
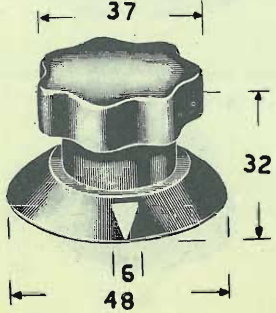
	Articolo		Prezzo listino
	F/56-1	Manopola per strumenti con piattello a indice in bachelite nera	326
	F/56-2	Manopola per strumenti con piattello a indice in bachelite nera	376
	F/56-3	Manopola per strumenti con piattello a indice in bachelite nera	462
	F/57	Manopola per strumenti con piattello a indice in bachelite nera	276
	F/58	Manopola per strumenti con piattello a indice in bachelite nera	400

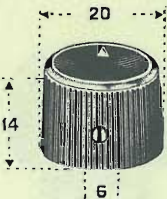
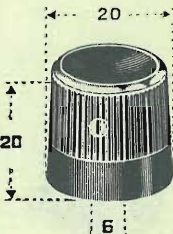
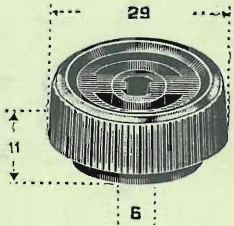
Prezzo listino		Articolo	
90	Manopola a indice in bachelite color grigio-bordatura con anellino nichelato 142	F/58-1	
86	Manopola a indice in urea color avorio bordatura con anellino in metallo color oro 142	F/58-2	
86	Manopola a indice in bachelite color marrone, bordatura con anellino in metallo color oro 142	F/59	
86	Manopola in bachelite color marrone bordatura con anellino in metallo color oro 141	F/59-1	
90	Manopola in bachelite color grigio bordatura con anellino nichelato 141	F/59-2	
86	Manopola in bachelite color nero bordatura con anellino in metallo color oro 141	F/59-3	
86	Manopola in urea color avorio bordatura con anellino in metallo color oro 141	F/59-4	
90	Piattello in bachelite color marrone bordatura con anellino in metallo color oro - da impiegare con manopola F/59 e F/59-1 140	F/59-7	
100	Piattello in bachelite color grigio bordatura con anellino nichelato da impiegare con manopola F/59-2 e F/58-1 140	F/59-8	
90	Piattello in bachelite color nero bordatura con anellino in metallo color oro da impiegare con manopola F/59-3 140	F/59-9	
90	Piattello in urea color avorio bordatura con anellino in metallo color oro - da impiegare con manopola F/58-2 e F/59-4 140	F/60	

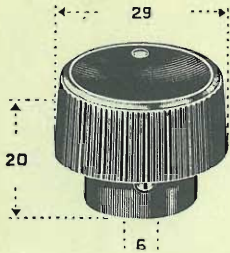
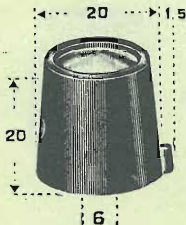
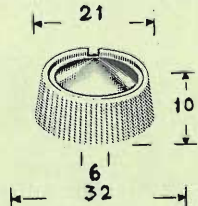
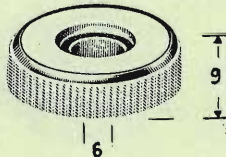
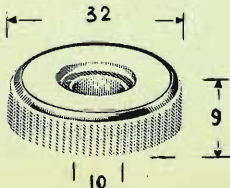
	Articolo		Prezzo listino
	F/60-1	Manopola a indice in bachelite color marrone - bordatura con anellino in metallo color oro 144	100
	F/60-2	Manopola a indice in bachelite color grigio - bordatura con anellino nichelato 144	110
	F/60-3	Manopola a indice in urea color avorio - bordatura con anellino in metallo color oro 144	100
	F/60-4	Manopola a indice in bachelite color marrone disco in metallo color oro 145	76
	F/60-5	Manopola a indice in bachelite color grigio disco in metallo nichelato 145	86
	F/60-6	Manopola a indice in urea color avorio disco in metallo color oro 145	76
	F/61	Manopola in urea color avorio disco in metallo color oro 20056	160
	F/62	Piattello in urea color avorio bordatura con anellino in metallo color oro 20057	184
	F/63	Piattello in urea color avorio bordatura con anellino in metallo color oro 20057	186
			
			

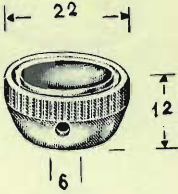
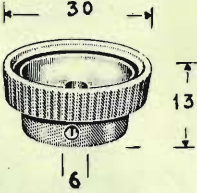
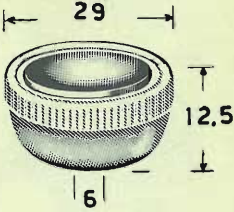
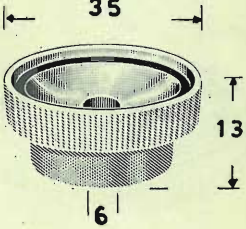
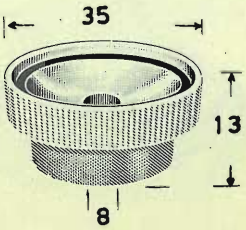
Prezzo listino		Articolo	
50	Manopola in urea color avorio disco in metallo color oro 20026	F/64	
50	Manopola in bachelite color marrone disco in metallo color oro 20026	F/66	
56	Piattello in urea color avorio bordatura con anellino in metallo color oro - da impiegare con manopola F/64 20027	F/65	
56	Piattello in bachelite color marrone bordatura con anellino in metallo color oro - da impiegare con manopola F/66 20027	F/67	
140	Manopola in urea color avorio disco in metallo color oro 20202	F/68	
140	Manopola in bachelite color marrone disco in metallo color oro 20202	F/68-1	
120	Piattello in urea color avorio bordatura con anellino in metallo color oro - da impiegare con manopola F/68 20126	F/69	
120	Piattello in bachelite color marrone bordatura con anellino in metallo color oro - da impiegare con manopola F/68-1 20126	F/69-1	

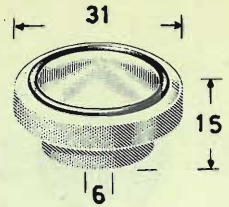
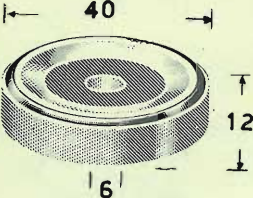
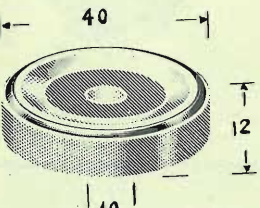
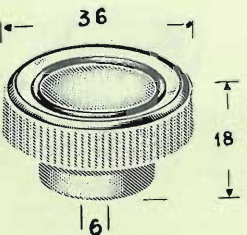
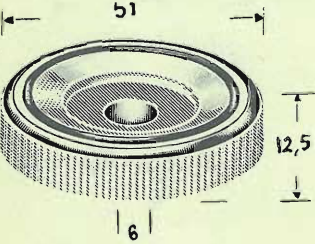
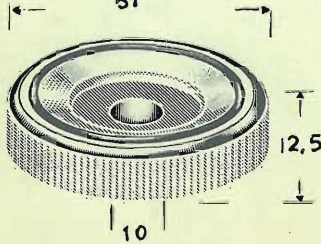
	Articolo		Prezzo listino
	F/70	Manopola in urea color avorio bordatura con anellino in metallo color oro 20114	138
	F/71	Piattello in urea color avorio bordatura con anellino in metallo color oro 20115	154
	F/72	Piattello in urea color avorio bordatura con anellino in metallo color oro 20115	154
	F/73	Manopola in urea color avorio bordatura con due anellini in metallo color oro 10278	214
	F/74	Piattello in urea color avorio bordatura con due anellini in metallo color oro 10279	204
	F/75	Piattello in urea color avorio bordatura con due anellini in metallo color oro 10279	204

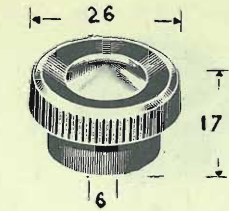
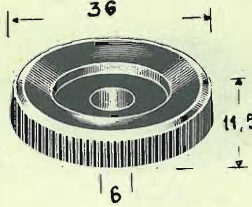
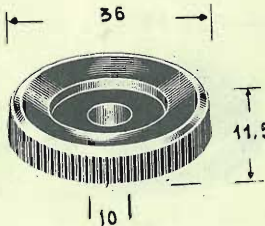
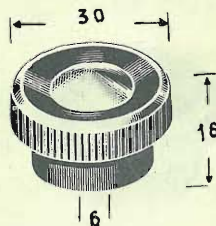
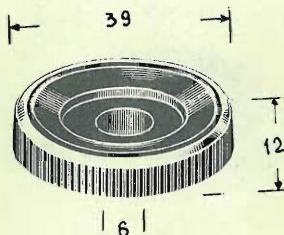
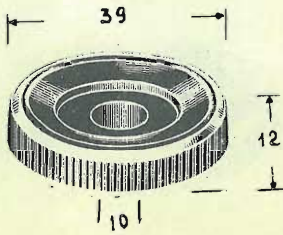

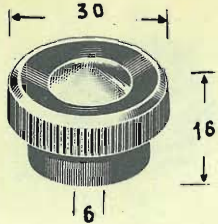
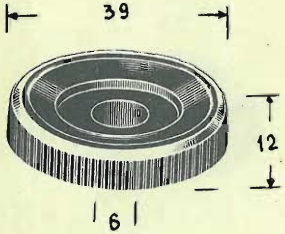
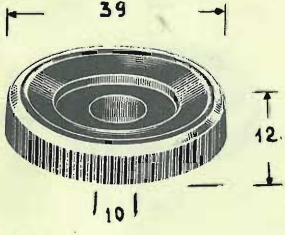
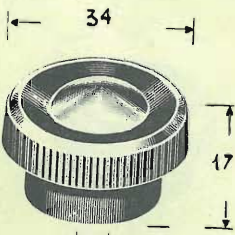
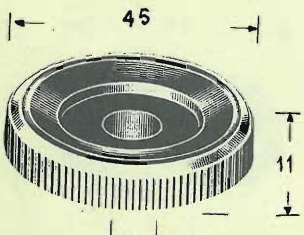
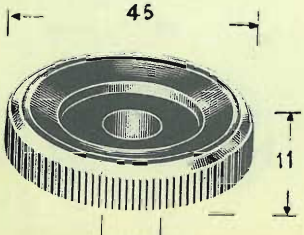
Prezzo listino		Articolo	
96	Manopola in bachelite color marrone disco e anellino in metallo color oro 10394	F/76	
118	Piattello in bachelite color marrone bordatura con anellino in metallo color oro 10395	F/77	
118	Piattello in bachelite color marrone bordatura con anellino in metallo color oro 10395	F/78	
98	Manopola in bachelite color marrone disco e anellino in metallo color oro 10280	F/79	
96	Piattello in bachelite color marrone bordatura con anellino in metallo color oro 10281	F/80	
118	Piattello in bachelite color marrone bordatura con anellino in metallo color oro 10281	F/81	

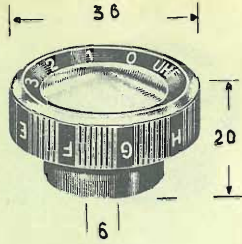
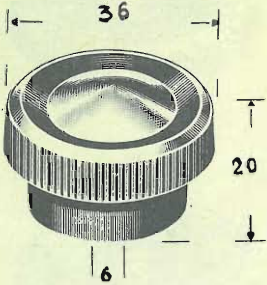
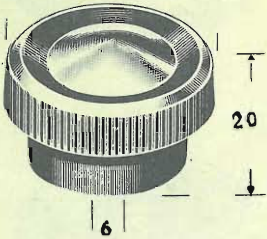
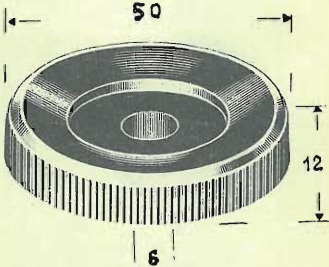
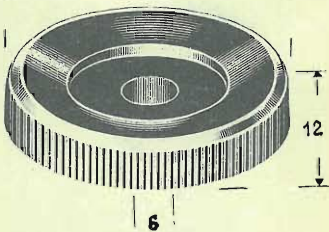
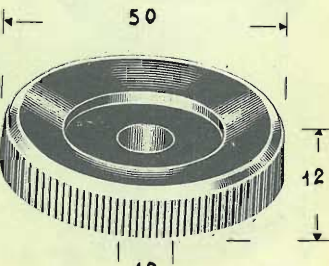
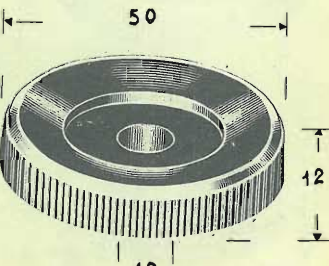
	Articolo		Prezzo listino
	F/82	Manopola in urea color avorio disco e anellino in metallo color oro 10280	180
	F/83	Piattello in urea color avorio bordatura con anellino in metallo color oro 10281	150
	F/84	Piattello in urea color avorio bordatura con anellino in metallo color oro - 10281	150
	F/85	Manopola in bachelite color marrone disco e anellino in metallo color oro - 10290	102
	F/86	Piattello in bachelite color marrone bordatura con anellino in metallo color oro - 10291	96
	F/87	Piattello in bachelite color marrone bordatura con anellino in metallo color oro - 10291	96

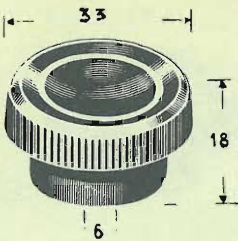
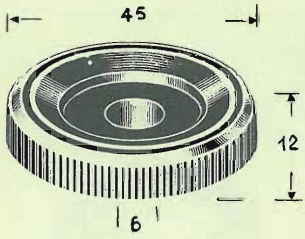
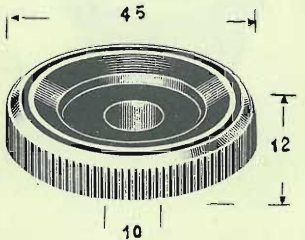
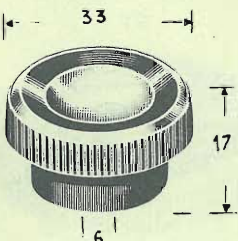
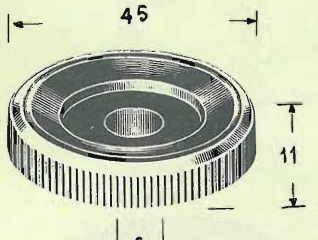
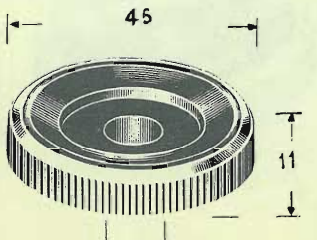
Prezzo listino		Articolo	
478	Manopola in bachelite color marrone disco e anellino in metallo color oro con numerazione canali - 10306	F/87-1	
102	Manopola in bachelite color marrone disco e anellino in metallo color oro - 10306	F/88	
200	Manopola in urea color avorio disco e anellino in metallo color oro - 10306	F/88-1	
130	Piattello in bachelite color marrone bordatura con anellino in metallo color oro - da impiegare con manopola F/88 - 10307	F/89	
186	Piattello in urea color avorio bordatura con anellino in metallo color oro - da impiegare con manopola F/88-1 - 10307	F/89-1	
130	Piattello in bachelite color marrone bordatura con anellino in metallo color oro - da impiegare con manopola F/88 - 10307	F/90	
186	Piattello in urea color avorio bordatura con anellino in metallo color oro - da impiegare con manopola F/88-1 - 10307	F/90-1	

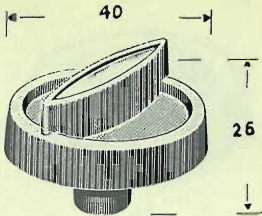
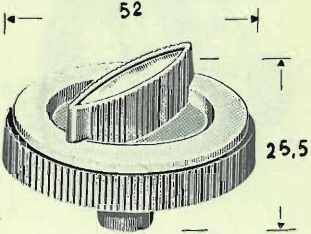
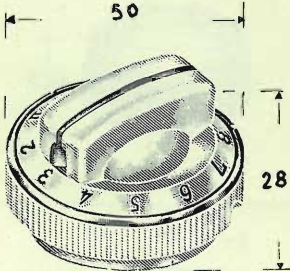
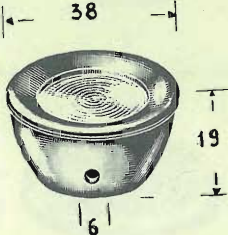
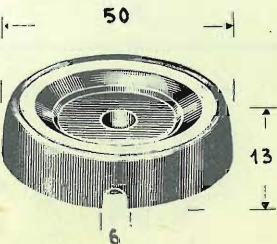
	Articolo		Prezzo listino
	F/91	Manopola in bachelite color marrone bordatura con due anellini in metallo color oro - 10435	122
	F/92	Piattello in bachelite color marrone bordatura con due anellini in metallo color oro - 10436	122
	F/93	Piattello in bachelite color marrone bordatura con due anellini in metallo color oro - 10436	122
	F/94	Manopola in bachelite color marrone disco e anellino in metallo color oro 10378	150
	F/95	Piattello in bachelite color marrone bordatura con anellino in metallo color oro - 10291	96
	F/96	Piattello in bachelite color marrone bordatura con anellino in metallo color oro - 10291	96

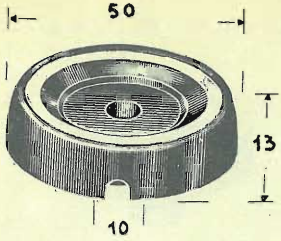
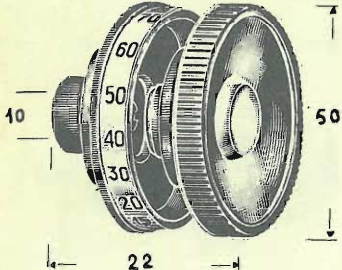
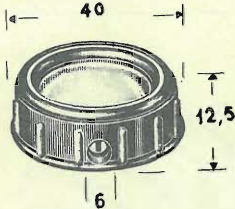
Prezzo listino	Articolo	Immagine
130	<p>Manopola in polistirolo color grigio disco in metallo color argento completa di piattelli con innesto a pressione adatta per gruppo UHF</p>	<p>F/96-1</p> 
190	<p>Manopola in polistirolo color grigio disco in metallo color argento completa di piattelli con innesto a pressione adatta per gruppo VHF</p>	<p>F/96-2</p> 
610	<p>Manopola in urea color avorio - indice a anellino in metallo color oro graduata per dodici posizioni \varnothing foro mm 6 piattello con foro centrale \varnothing mm 10 due fori di fissaggio distanti mm 23 20089 - 10551/6 - 10551/10</p>	<p>F/97</p> 
168	<p>Manopola in bachelite color nero disco in metallo color oro - 10521</p>	<p>F/97-1</p> 
168	<p>Piattello in bachelite color nero bordatura con anellino in metallo color oro - 20063</p>	<p>F/97-2</p> 

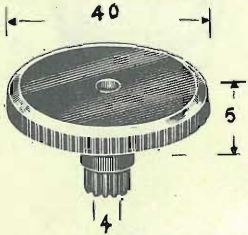
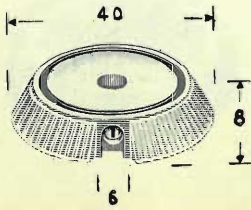
	Articolo		Prezzo listino
	F/97-3	Piattello in bachelite color nero bordatura con anellino in metallo color oro - 20063	168
	F/97-4	Manopola in polistirolo color marrone speciale per UHF (2° canale)	160
	F/99-1	Manopola in bachelite color marrone disco e filettatura in metallo color oro - 10159	130
	F/99-2	Manopola in bachelite color marrone disco e filettatura in metallo color oro - 10161	200
	F/100	Manopola in bachelite color marrone per TV - bordatura con anellino in metallo color oro - 10386	194
	F/100-1	Manopola in urea color avorio bordatura con filetto dorato - 20032	78

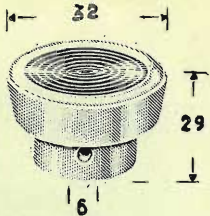
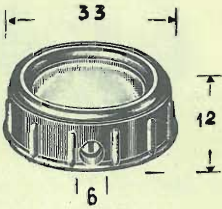
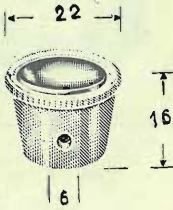
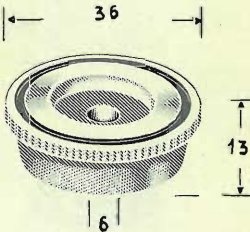
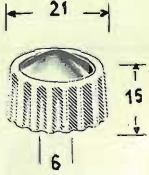
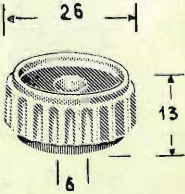
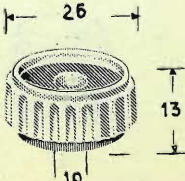

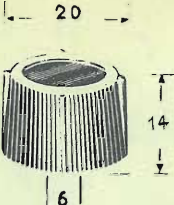
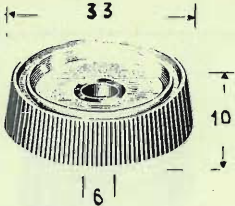
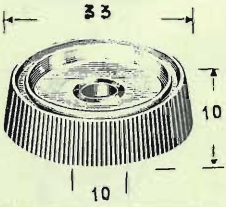
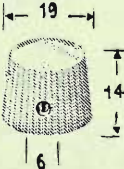
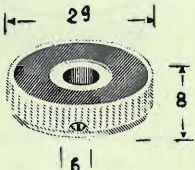
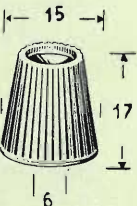
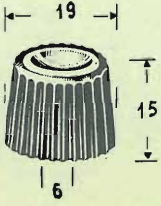
Prezzo listino		Articolo	
172	Manopola in urea color avorio disco in metallo color oro - 20074	F/100-2	
118	Manopola in bachelite color marrone disco e filettatura in metallo color oro - 10179	F/100-3	
96	Manopola in urea color avorio disco in metallo color oro - 20035	F/100-4	
82	Piattello in urea color avorio bordatura con filetto in metallo color oro - 20036	F/100-5	
36	Manopola in urea color avorio disco in metallo color oro	F/109	
78	Piattello in urea color avorio	F/110	
86	Piattello in urea color avorio	F/111	

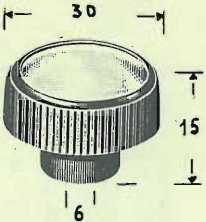
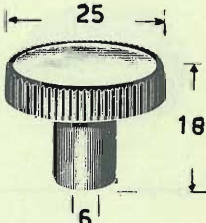
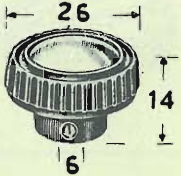
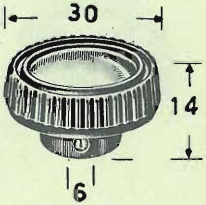
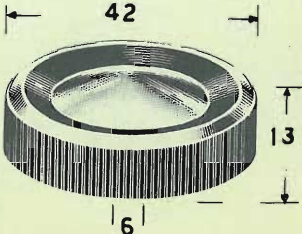
  	<p>Articolo</p> <p>F/112</p>	<p>Manopola in urea color avorio disco in metallo color oro</p>	<p>Prezzo listino</p> <p>40</p>
 	<p>F/115</p>	<p>Manopola in urea color avorio</p>	<p>98</p>
	<p>F/117</p>	<p>Manopola in polistirolo color grigio disco in metallo color argento innesto a pressione</p>	<p>66</p>
	<p>F/119</p>	<p>Manopola in polistirolo color marrone disco in metallo color oro</p>	<p>40</p>

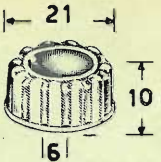
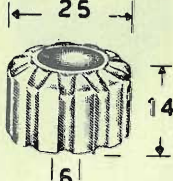
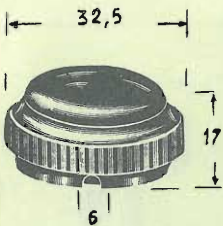
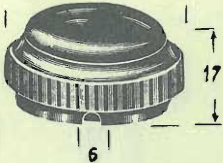
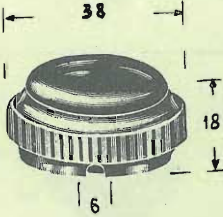
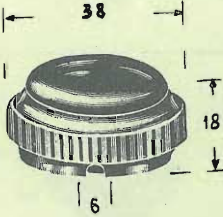
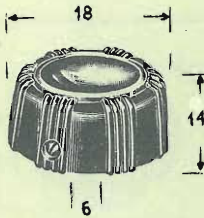
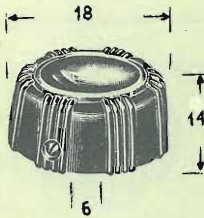
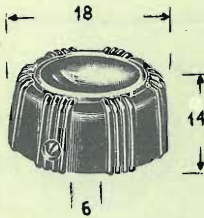
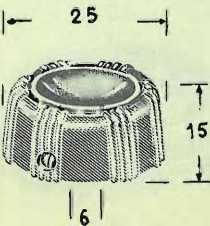
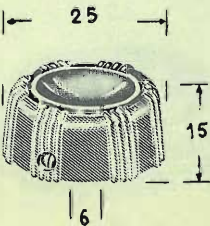
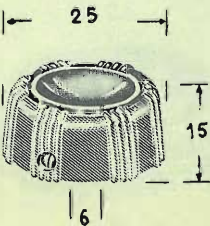
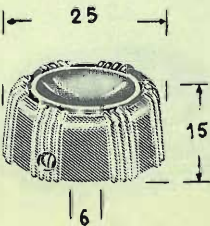
Prezzo listino		Articolo	
62	Manopola in bachelite color marrone centro avorio	F/121	
62	Manopola in urea color avorio centro marrone	F/122	
62	Manopola in urea color avorio disco in metallo color oro	F/123	
76	Manopola in polistirolo color marrone disco in metallo color oro innesto a pressione	F/125	
62	Manopola in bachelite color marrone disco in metallo color oro	F/126	
72	Manopola in bachelite color marrone disco in metallo color oro	F/127	
120	Manopola in bachelite color marrone disco e anellino in metallo color oro	F/128	

	Articolo		Prezzo listino
	F/130	Manopola in urea color avorio disco in metallo color oro	40
	F/131	Manopola in urea color avorio disco in metallo color oro	46
	F/132	Manopola in urea color avorio bordatura con anellino in metallo color oro	82
	F/133	Manopola in bachelite color marrone bordatura con anellino in metallo color oro	82
	F/134	Manopola in urea color avorio bordatura con anellino in metallo color oro	92
	F/135	Manopola in bachelite color marrone bordatura con anellino in metallo color oro	92
	F/136	Manopola in plexiglas disco in metallo color oro	42
	F/137	Manopola in bachelite color marrone disco in metallo color oro	42
	F/138	Manopola in urea color avorio disco in metallo color oro	42
	F/139	Manopola in urea color avorio disco in metallo color oro	60
	F/140	Manopola in plexiglas disco in metallo color oro	60
	F/141	Manopola in bachelite color marrone disco in metallo color oro	60

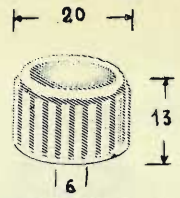
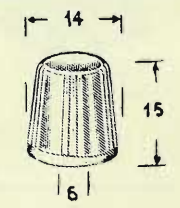
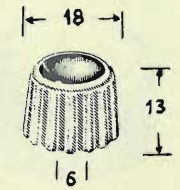
Prezzo Listino		Articolo	
72	Manopola in plexiglas disco in metallo color oro	F/142	
72	Manopola in urea color avorio disco in metallo color oro	F/143	
72	Manopola in bachelite color marrone disco in metallo color oro	F/144	
72	Manopola in urea color avorio disco in metallo color oro	F/149	
86	Manopola in urea color avorio disco e anellino in metallo color oro	F/153	
86	Manopola in bachelite color marrone disco e anellino in metallo color oro	F/153-1	
60	Manopola in urea color avorio disco e anellino in metallo color oro	F/154	
60	Manopola in bachelite color marrone disco e anellino in metallo color oro	F/154-1	
166	Manopola in urea color avorio disco in metallo color oro 20058	F/155	
166	Manopola in bachelite color grigio disco in metallo color oro 20058	F/156	

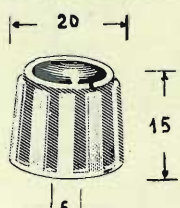
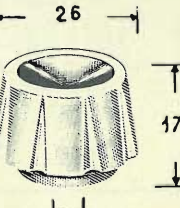
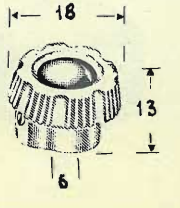
	Articolo		Prezzo listino
	F/161	Manopola in urea color avorio	42
	F/162	Manopola in urea color avorio	26
	F/163	Manopola in bachelite color marrone	26
	F/164	Manopola in urea color avorio disco in metallo color oro	36
	F/165	Manopola in urea color avorio disco in metallo color oro	32
	F/167	Manopola in bachelite color grigio disco in metallo color argento - 10760	190
	F/168	Manopola in urea color avorio disco in metallo color oro - 20221	166
	F/171	Manopola in urea color avorio disco in metallo color oro	40

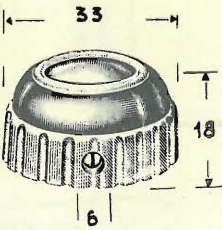
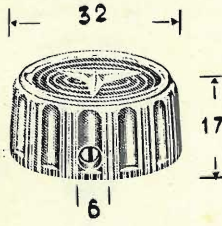
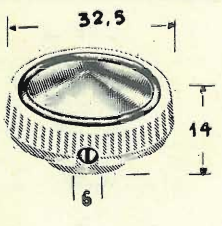
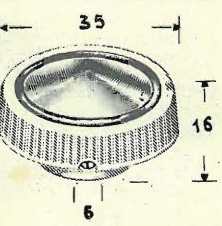
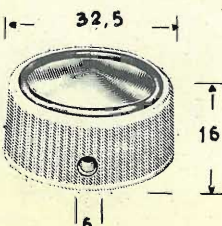
Prezzo listino		Articolo	
88	Manopola in bachelite color marrone disco e anellino in metallo color oro	F/172	
72	Manopola in bachelite color marrone disco in metallo color oro bordatura in avorio	F/173	
72	Manopola in urea color avorio disco in metallo color oro bordatura in amaranto	F/174	
88	Manopola in urea color avorio disco e anellino in metallo color oro	F/175	
82	Manopola in urea color avorio ricoperta in plexiglas disco in metallo color oro	F/176	
78	Manopola in urea color avorio disco in metallo color oro	F/177	
78	Manopola in urea color avorio disco in metallo color oro	F/178	
88	Manopola in urea color avorio disco in metallo color oro	F/179	

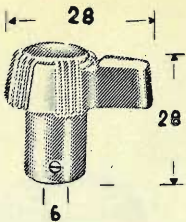
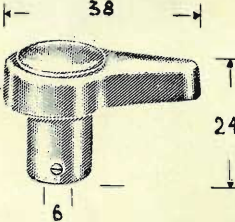
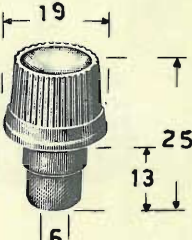
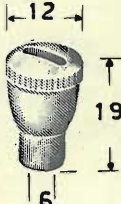
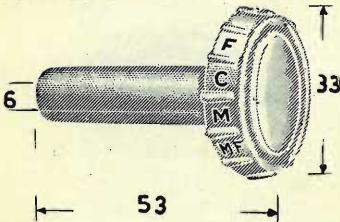
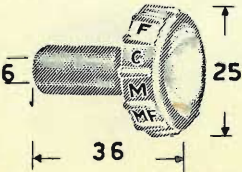
	Articolo		Prezzo listino
	F/181	Manopola a indice in urea color avorio	68
	F/182	Manopola a indice in urea color avorio	68
	F/183	Manopola in bachelite color marrone disco in metallo color oro innesto a pressione	62
	F/184	Manopola in vipla per TV - colori assortiti	16
	F/185	Manopola in urea color avorio per cambio onda per K2/199	56
	F/186	Manopola in urea color avorio per cambio onda per K3/10	38
	F/187	Manopola in urea color avorio per cambio onda per K2/10	40

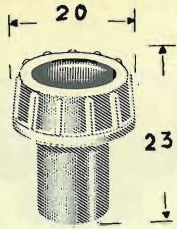
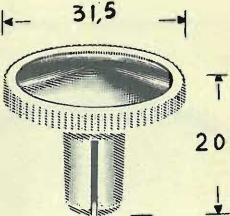
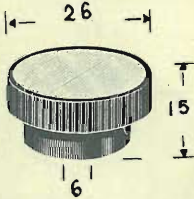
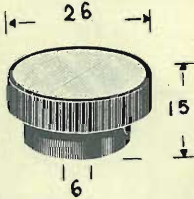
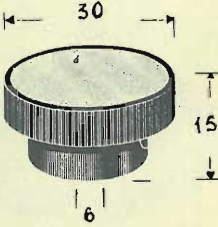
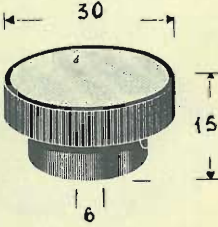
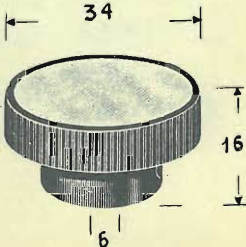
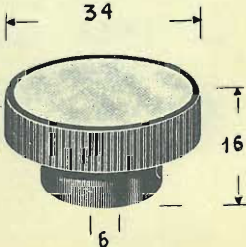
Prezzo listino		Articolo	
56	Manopola in urea color avorio disco in metallo color oro innesto a pressione per apparecchi FM/2	F/191	
26	Manopola in bachelite color grigio disco in metallo color oro innesto a pressione per apparecchi AR/4 la coppia	F/192	
96	Manopola in bachelite color marrone disco in metallo color oro	F/195	
100	Manopola in bachelite color grigio disco in metallo color argento	F/195-1	
98	Manopola in bachelite color marrone disco in metallo color oro	F/196	
102	Manopola in bachelite color grigio disco in metallo color argento	F/196-1	
102	Manopola in bachelite color marrone disco in metallo color oro	F/197	
110	Manopola in bachelite color grigio disco in metallo color argento	F/197-1	

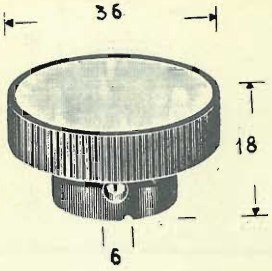
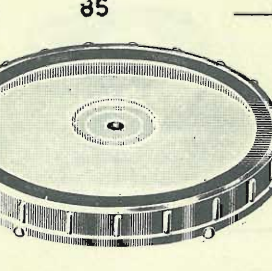
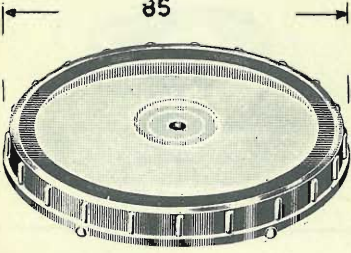
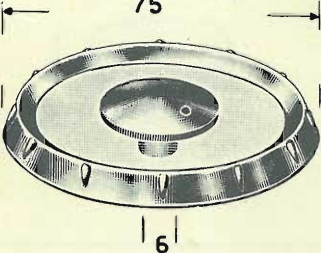
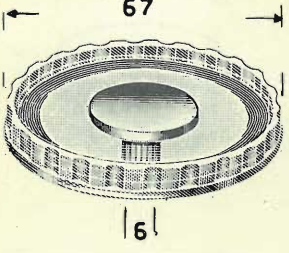
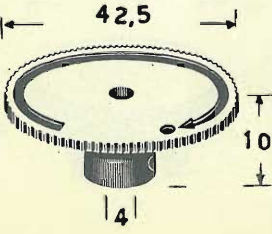
	Articolo F/198	Manopola in bachelite color marrone disco in metallo color oro	Prezzo listino 102
	F/198-1	Manopola in bachelite color grigio disco in metallo color argento	110
	F/205	Manopola di sintonia in plexiglas disco in metallo color oro per apparecchi « FM/2 » innesto a pressione	300
	F/207	Manopola di sintonia in plexiglas disco e anellino in metallo color oro adatta per apparecchi « Herman » innesto a pressione	400
	F/213	Manopola di sintonia in plexiglas disco in metallo color oro adatta per apparecchi « AR 20 » e « SM 3350 » innesto a pressione	126
	F/214	Manopola per controllo volume in polistirolo color grigio adatta per apparecchi « AR 20 » e « SM 3350 »	76

MANOPOLE SPECIALI IN BACHELITE NERA PER STRUMENTI

Prezzo Listino	Dimensioni in mm			Articolo
	A	B	C	
330	19	12	6	F/250
386	25	15	6	F/252
600	31	19	6	F/254
630	40	19	6	F/256
936	45	27,5	6	F/258
936	45	27,5	8	F/260
1266	58	35	6	F/262
1266	58	35	8	F/264
1266	58	35	10	F/266
1760	75	44	6	F/268
1760	75	44	8	F/270
1760	75	44	10	F/272

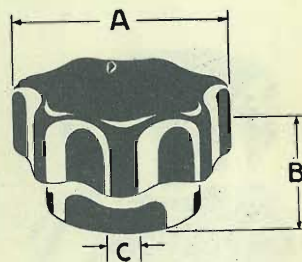

MANOPOLE SPECIALI IN BACHELITE NERA PER STRUMENTI

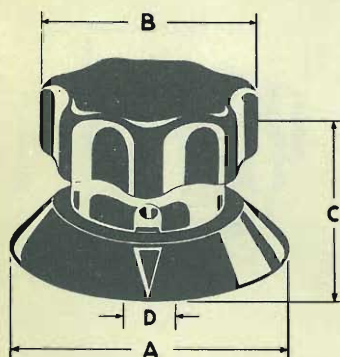

Articolo	Dimensioni in mm				Prezzo Listino
	A	B	C	D	
F/300	21	19	16	6	440
F/302	32	25	22	6	500
F/304	40	31	27	6	680
F/306	40	40	27	6	716
F/308	48	40	27,5	6	770
F/310	58	45	36,5	6	1050
F/312	58	45	36,5	8	1050
F/314	58	45	36,5	10	1050
F/316	75	58	46	6	1430
F/318	75	58	46	8	1430
F/320	75	58	46	10	1430
F/322	90	58	44	6	1540
F/324	90	58	44	8	1540
F/326	90	58	44	10	1540
F/328	90	75	53	6	2420
F/330	90	75	53	8	2420
F/332	90	75	53	10	2420
F/334	110	75	54	10	2420

MANOPOLE SPECIALI PER STRUMENTI CON PIATTELLO AD INDICE E FORO SUPERIORE

Dimensioni in mm

Articolo	F/350	F/352	F/354	F/356	F/358	F/360	F/362	F/364
diseg.	A	A	A	B	B	C	C	C
d 1	40	40	50	40	40	40	40	50
d 2	6	8	8	6	8	6	8	8
d 3	26	26	32	26	26	26	26	32
d 5	3,5	4,5	4,5	3,5	4,5	3,5	4,5	4,5
d 6	7	9	9	7	9	7	9	9
d 8	Fil. 2,6	Fil. 2,6	Fil. 2,6	Fil. 2,6	Fil. 2,6	Fil. 2,6	Fil. 2,6	Fil. 2,6
d 9	48	48	60	48	48	48	48	60
h 1	26	26	32	26	26	26	26	32
h 3	35	35	41	35	35	35	35	41
n	2,2	2,7	2,7	2,2	2,7	2,2	2,7	2,7
r 6	14,5	14,5	17	14,5	14,5	14,5	14,5	17
t 1	14	15	16	14	15	14	15	16
t 2	1,4	1,4	1,4	1,4	1,4	1,4	1,4	1,4
t 3	4	5	5	4	5	4	5	5
V	17	17	17	17	17	17	17	17
Prezzo Listino	1000	946	1150	946	946	630	630	850

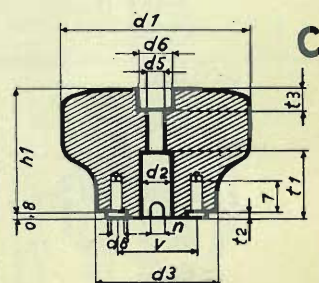
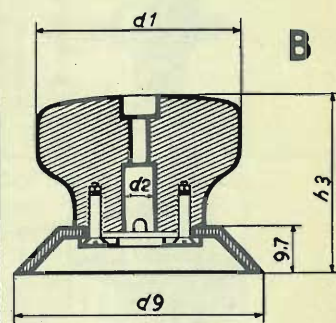
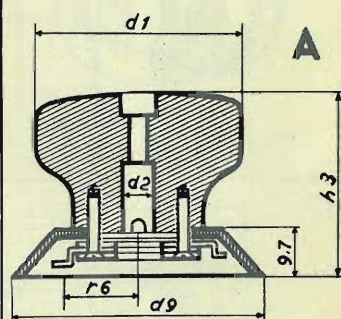
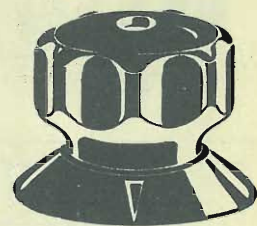

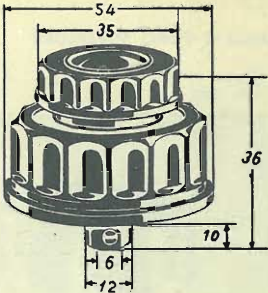
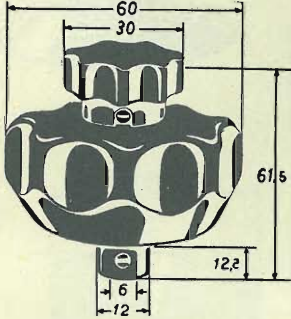
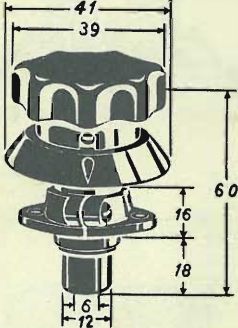
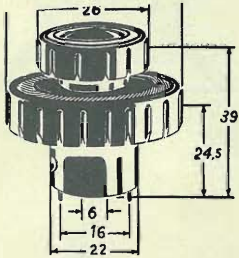
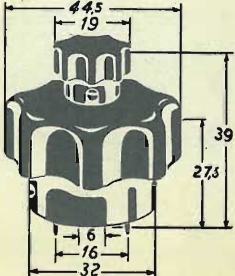
	Articolo		Prezzo listino
	F/370	Manopola doppia con demoltiplica. Possibilità di regolazione diretta e demoltiplicata Bachelite nera Rapporto: 6 : 1 120 - 1	3750
	F/372	Manopola doppia con demoltiplica Bachelite nera Rapporto: 6 : 1 120 - 2	4750
	F/374	Manopola con regolazione demoltiplicata Bachelite nera Piattello con indice Rapporto: 6 : 1 120 - 3	4100
	F/376	Manopola doppia con demoltiplica tipo « Automat » Bachelite nera Rapporto: 6 : 1 125 - 1	2200
	F/378	Manopola doppia con demoltiplica tipo « Automat » Bachelite nera Rapporto: 6 : 1 125 - 2	3026

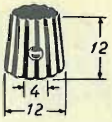
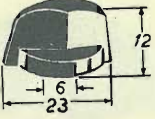
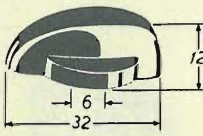
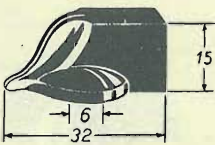
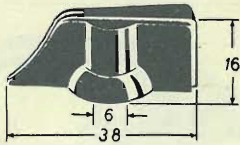
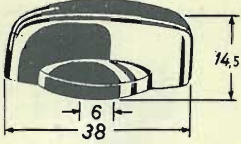
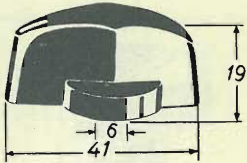
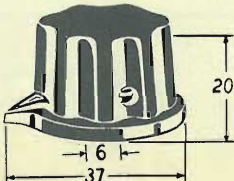
Prezzo listino		Articolo	
150	Manopola in bachelite nera 341 - 41	F/390	
158	Manopola a indice in bachelite nera 390 - 61	F/392	
166	Manopola a indice in bachelite nera 391 - 61	F/396	
216	Manopola a indice in bachelite nera 392 - 611	F/398	
216	Manopola a indice in bachelite nera 393 - 611	F/400	
216	Manopola a indice in bachelite nera 395 - 611	F/402	
220	Manopola a indice in bachelite nera 394 - 611	F/404	
270	Manopola a indice in bachelite nera 396 - 611	F/406	

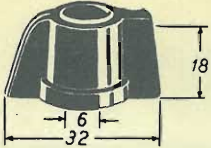
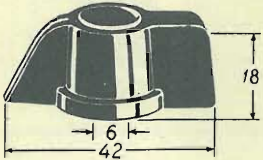
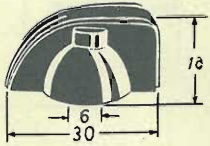
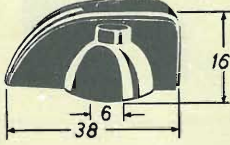
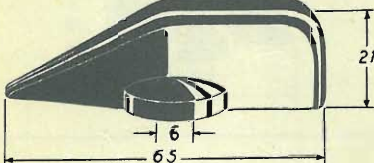
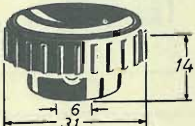
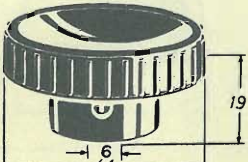
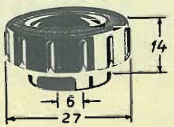
	Articolo		Prezzo listino
	F/410	Manopola a indice in bachelite nera 398 - 611	260
	F/412	Manopola a indice in bachelite nera 399 - 611	210
	F/414	Manopola a indice in bachelite nera 400 - 611	216
	F/416	Manopola a indice in bachelite nera 401 - 611	350
	F/418	Manopola in bachelite nera 540 - 611	200
	F/420	Manopola in bachelite nera 541 - 611	230
	F/422	Manopola in bachelite nera 542 - 61	156





Prezzo listino		Articolo	
216	Manopola in bachelite nera 543 - 61	F/424	
180	Manopola in bachelite nera 544 - 61	F/426	
240	Manopola in bachelite nera 342 - 61	F/428	
260	Manopola in bachelite nera 545 - 611	F/430	
360	Manopola speciale per strumenti con piattello ad indice Bachelite nera 342 - 611	F/432	
836	Manopola speciale per strumenti con piattello graduato Graduazione di 10° in 10° sino a 360° Bachelite nera 350 - 611	F/434	
870	Manopola speciale per strumenti con piattello graduato Graduazione di 10° in 10° sino a 360° Bachelite nera 351 - 611	F/436	

Figura	Articolo	Giradischi	Cartuccia	Dia- mante	Zaffiro	Norm. 78''	L.P.16/ 33/45	Stereo	Prezzo listino
	R/1501	Lesca	B		▲		▲		210
	R/1501-1	Lesca	B	▲			▲		3750
	R/1502	Lesca	B		▲	▲			210
	R/1511	Lesca	E		▲		▲		240
	R/1511-1	Lesca	E	▲			▲		3750
	R/1512	Lesca	E		▲	▲			240
	R/1521	Lesca Braun Audiofon Collaro GBC Telefunken Garis Lenco Primafon Perpectuum Faro Fonmusic Webster	D Ronette DC 284/ov Duplo Kristall TO 284 PE				▲	▲	240
	R/1521-1	Lesca Braun Audiofon Collaro GBC Telefunken Garis Lenco Primafon Perpetuum Faro Fonmusic Webster	D Ronette DC 284/ov Duplo Kristall TO 284 PE		▲		▲		3750
	R/1522	Lesca Braun Audiofon Collaro GBC Telefunken Garis Lenco Primafon Perpetuum Faro Fonmusic Webster	D Ronette DC 284/ov Duplo Kristall TO 284 PE			▲	▲		240



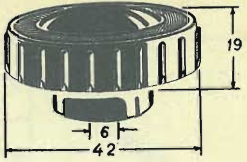
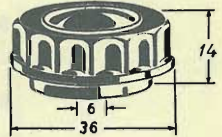
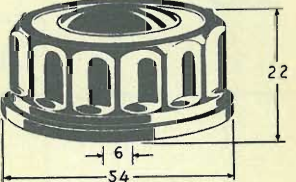
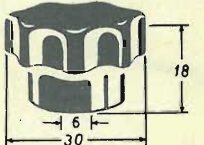
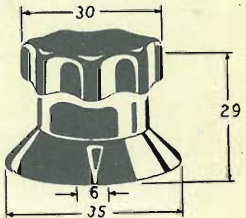
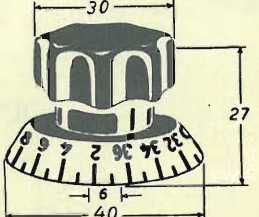
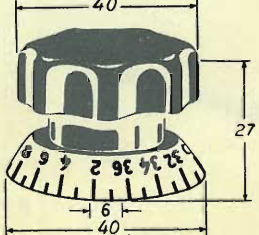







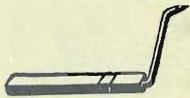

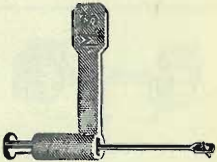





Prezzo listino	Giradischi	Cartuccia	Dia- mante	Zaffiro	Norm. 78''	-P.16/ 33/45	Stereo	Articolo	Figura
300	Lesca Astatic	A T		▲		▲		R/1531	
300	Lesca Astatic	A T		▲	▲			R/1532	
480	Lesca	S		▲			▲	R/1533	
600	Lesca	U		▲	▲	▲	▲	R/1535	
270	Schumann	SK 452		▲		▲		R/1536	
270	Schumann	SK 452		▲	▲			R/1536-1	
420	Schumann	SK 453		▲		▲		R/1537	
420	Schumann	SK 453		▲	▲			R/1537-1	
480	Schumann	Merula STK 490		▲			▲	R/1537-3	
350	Astatic Roc-Ola	G		▲		▲		R/1538	
350	Astatic Roc-Ola	G		▲	▲			R/1538-1	
270	Stare			▲		▲		R/1539	
270	Stare			▲	▲			R/1539-1	
300	SW 59			▲		▲		R/1540	
300	SW 59			▲	▲			R/1540-1	
600	Lenco			▲	▲	▲		R/1541	
300	Ariston GBC Gelosio Garrard Columbia Astatic	Q		▲		▲		R/1551	
300	Ariston GBC Gelosio Garrard Columbia Astatic	Q		▲	▲			R/1552	

Figura	Articolo	Giradischi	Cartuccia	Dia- mante	Zaffiro	Norm. 78"	L.P.16/ 33/45	Stereo	Prezzo listino
	R/1553	Astatic	K		▲		▲		480
	R/1554	Astatic	K		▲	▲			480
	R/1556	Columbia	SC 1		▲			▲	600
	R/1558	Decca	H		▲		▲		660
	R/1559	Decca	H		▲	▲			660
	R/1561	BSR Plessey Monarch Radiohm Acos	} Acos HGP 59		▲		▲		300
	R/1562	BSR Plessey Monarch Radiohm Acos			▲	▲			300
	R/1565	Garrard Eden 59			▲		▲		600
	R/1566	Garrard Eden 59			▲	▲			600
	R/1567	Eden			▲		▲		240
	R/1568	Eden			▲	▲			240
	R/1569	Eden	Stereo		▲			▲	600
	R/1571	BSR Monarch			▲	▲			300
	R/1572	BSR Monarch			▲		▲		300
	R/1581	BSR Plessey	} Acos HGP 37-1		▲		▲		300
	R/1582	BSR Plessey			▲	▲			300

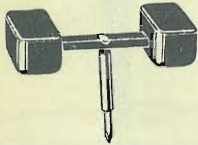



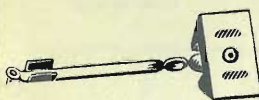









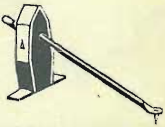

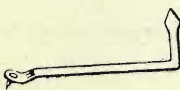

Prezzo listino	Giradischi	Cartuccia	Dia- mante	Zaffiro	Norm. 78"	L.P.16/ 33/45	Stereo	Articolo	Figura
300	BSR	Stereo		▲			▲	R/1585	
600	Philips 2 V	AG 3001 AG 3109		▲	▲	▲		R/1591	
270	Philips	AG 3010 AG 3013		▲		▲		R/1601	
270	Philips	AG 3010 AG 3013		▲	▲			R/1602	
300	Philips 4 V	AG 3016		▲		▲		R/1603	
3750	Philips 4 V	AG 3016	▲			▲		R/1603-1	
300	Philips 4 V	AG 3016		▲	▲			R/1604	
270	Philips	AG 3019		▲		▲		R/1605	
270	Philips	AG 3019		▲	▲			R/1605-1	
3750	Philips	AG 3060	▲				▲	R/1606	
480	Philips	AG 3063		▲			▲	R/1607	
720	Philips	AG 3052 AG 5001		▲	▲	▲		R/1608	
1200	Philips	AG 5012 AG 5013		▲		▲		R/1609	
1200	Philips	AG 5012 AG 5013		▲	▲			R/1609-1	
480	Philips	AG 3301 AG 3304		▲		▲		R/1610	
480	Philips	AG 3301 AG 3304		▲	▲			R/1610-1	

Figura	Articolo	Giradischi	Cartuccia	Dia- mante	Zaffiro	Norm. 78''	L.P.16/ 33/45	Stereo	Prezzo listino
	R/1611-1	Admiral 409 B/19-8			▲		▲		300
	R/1611-2	Admiral 409 B/19-8			▲	▲			300
	R/1612	GBC Teppaz Visseau	R/1357		▲		▲		240
	R/1613	GBC Teppaz Visseau	R/1357		▲	▲			240
	R/1614	Teppaz	Stereo		▲			▲	300
	R/1615	Collaro Braun	SK 451 Schumann		▲		▲		270
	R/1616	Collaro Braun	SK 451 Schumann		▲	▲			270
	R/1617	Magnavox	560133 560170		▲	▲	▲		600
	R/1617-1	Philco Magnavox			▲	▲	▲		540
	R/1618	R.C.A.	72345		▲		▲		510
	R/1618-1	R.C.A.	72345		▲	▲			510
	R/1618-2	R.C.A.	75497		▲		▲		480
	R/1618-3	R.C.A.	75497		▲	▲			480
	R/1619	R.C.A.	74068		▲		▲		480
	R/1619-1	R.C.A.	74068		▲	▲			480
	R/1620	R.C.A.	104		▲	▲	▲	▲	900
	R/1620-1	R.C.A.	106770		▲			▲	360















Prezzo listino	Giradischi	Cartuccia	Dia- mante	Zaffiro	Norm. 78"	L.P.16/ 33/45	Stereo	Articolo	Figura
600	Plessey Dual			▲	▲	▲		R/1621	
510	Luxor	72411		▲	▲	▲		R/1631	
900	Luxor Stereo	72786		▲	▲	▲	▲	R/1632	
600	Luxor Stereo	74916		▲	▲	▲	▲	R/1633	
390	Elac	KST 2		▲		▲		R/1634	
390	Elac	KST 2		▲	▲		R/1634-1		
630	Elac	SM 11		▲		▲		R/1634-2	
630	Elac	SM 11		▲	▲		R/1634-3		
630	Elac	SNM 14		▲	▲	▲		R/1634-4	
630	Elac	SM 21		▲		▲		R/1634-5	
630	Elac	SM 21		▲	▲		R/1634-6		
570	Elac	SM-103		▲			▲	R/1635	
690	Elac	SNM 104 PE 182 US		▲	▲	▲	▲	R/1635-1	
690	Elac	SNM 100 PE 180 US		▲	▲	▲	▲	R/1635-2	

Figura	Articolo	Giradischi	Cartuccia	Dia- mante	Zaffiro	Norm. 78"	L.P.16/ 33/45	Stereo.	Prezzo listino
	R/1635-3	Elac	SM 101		▲			▲	570
	R/1635-4	Elac	SNM 102		▲	▲	▲	▲	690
	R/1635-5	Elac	SNM 106		▲	▲	▲		2100
	R/1635-6	Elac	STS 210		▲		▲		2550
	R/1635-7	Elac	STS 210		▲	▲			2550
	R/1636	Seeburg	R 150		▲		▲		270
	R/1636-1	Seeburg	R 150		▲	▲			270
	R/1637	Fentone	H 51		▲		▲		840
	R/1638	Fentone	H 51		▲	▲			840
	R/1639	Seeburg	Stereo		▲			▲	2700
	R/1640	Seeburg Juke box		▲			▲		3750
	R/1640-1	Seeburg Juke box			▲		▲		1200
	R/1641	Telefunken Braun Grundig			▲	▲	▲		450
	R/1642	Shure	PC 2		▲	▲	▲		810

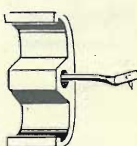
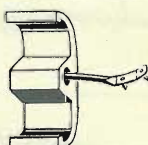
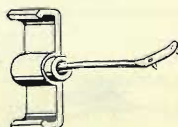
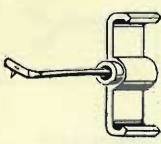
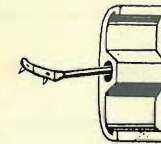
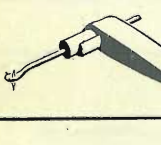



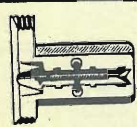

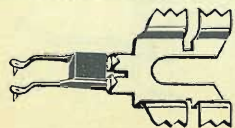









Prezzo listino	Giradischi	Cartuccia	Dia- mante	Zaffiro	Norm. 78"	L.P.16/ 33/45	Stereo	Articolo	Figura
850	Shure	WC 6 PC 6		▲	▲	▲		R/1643	
550	Shure	PC 9 WC 38		▲		▲		R/1644	
550	Shure	PC 9 WC 38		▲	▲			R/1644-1	
680	Shure	WC 20 PC 20		▲		▲		R/1645	
680	Shure	WC 20 PC 20		▲	▲			R/1645-1	
510	Shure	WC 32		▲		▲		R/1646	
510	Shure	WC 32		▲	▲			R/1646-1	
350	Shure	P 73		▲		▲		R/1647	
350	Shure	P 73		▲	▲			R/1647-1	
2850	Shure	M 7 D		▲			▲	R/1648	
600	Dual	CDS/320 CDS/520		▲	▲	▲	▲	R/1650	
390	Dual	CDS 2 CDS 3		▲	▲	▲		R/1651	
3750	Dual	CDS 2 CDS 3	▲		▲	▲		R/1651-1	
390	Dual	CDS 1		▲	▲	▲		R/1652	

Figura	Articolo	Giradischi	Cartuccia	Dia- mante	Zaffiro	Norm. 78''	L.P.16/ 33/45	Stereo	Prezzo listino
	R/1654	Dual 1006/T5	CDS 420		▲		▲	▲	600
	R/1655	Dual 1006/T5	CDS 420	▲			▲	▲	3750
	R/1656	Tonnoy	MK 2		▲		▲		900
	R/1657	Tonnoy	MK 2		▲	▲			900
	R/1658	Telefunken	200		▲	▲	▲		900
	R/1659	Telefunken	A 20/2		▲	▲	▲	▲	1140
	R/1661	Perpetuum Elac	PE 5 SN 12		▲	▲	▲		490
	R/1662	Perpetuum Elac	PE-8/PE-10 SNM 9		▲	▲	▲		490
	R/1663	Perpetuum Elac	PE-8/PE-10 SNM 9	▲		▲	▲		3750
	R/1681	Perpetuum	PE 12		▲	▲	▲		480
	R/1682	Perpetuum	PE 7000		▲		▲		540
	R/1683	Perpetuum	PE 7000		▲	▲			540
	R/1684	Old Models			▲		▲		450
	R/1684-1	Old Models			▲	▲			450

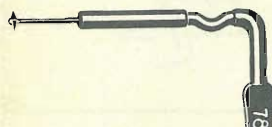
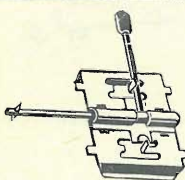









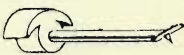

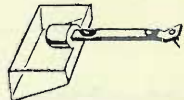
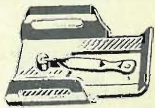



Prezzo listino	Giradischi	Cartuccia	Dia- mante	Zaffro	Norm. 78"	L.P.16/ 33/45	Stereo	Articolo	Figura
240	Pathé Marconi 51			▲		▲		R/1685	
240	Pathé Marconi 51			▲	▲			R/1685-1	
540	Pathé	RC 7		▲		▲		R/1686	
540	Pathé	RC 7		▲	▲			R/1686-1	
240	Pathé Marconi 53			▲		▲		R/1687	
240	Pathé Marconi 53			▲	▲			R/1687-1	
540	Pathé	stereo		▲			▲	R/1688	
540	Pathé	RC 5/6		▲		▲		R/1689	
540	Pathé	RC 5/6		▲	▲			R/1689-1	
300	Acos	GP 19		▲		▲		R/1691	
300	Acos	GP 19		▲	▲			R/1692	
600	Acos	GP 73/1		▲	▲	▲	▲	R/1697	
300	Acos	GP 29		▲		▲		R/1698	
300	Acos	GP 29		▲	▲			R/1698-1	
400	Acos	GP 33		▲		▲		R/1699	
400	Acos	GP 33		▲	▲			R/1699-1	

Figura	Articolo	Giradischi	Cartuccia	Dia- mante	Zaffiro	Norm. 78''	L.P.16/ 33/45	Stereo	Prezzo listino
	R/1700	Acos	GP 65		▲		▲		330
	R/1700-1	Acos	GP 65		▲	▲			330
	R/1700-5	Acos	GP 71/3		▲			▲	400
	R/1701	Monarch	TC 4		▲		▲		300
	R/1702	Monarch	TC 4		▲	▲			300
	R/1703	Miniature	HMV		▲		▲		240
	R/1704	Miniature	HMV		▲	▲			240
	R/1705	Thorens			▲	▲	▲		480
	R/1706	Garrard	TOM 1		▲	▲	▲		660
	R/1707	Garrard	TOM 2		▲	▲	▲		660
	R/1721	Garrard	GC 2		▲		▲		380
	R/1722	Garrard	GC 2		▲	▲			380
	R/1741	Garrard	Astatic		▲		▲		380
	R/1742	Garrard	Astatic		▲	▲			380
	R/1743	Garrard	GC 8		▲		▲		380
	R/1744	Garrard	GC 8		▲	▲			380



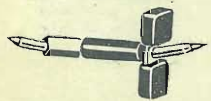
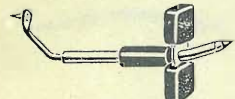









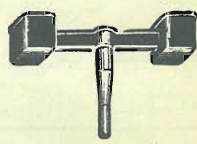





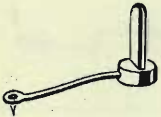



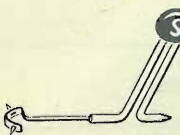
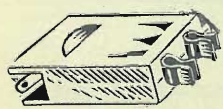



Prezzo listino	Giradischi	Cartuccia	Dia- mante	Zaffiro	Norm. 78''	L.P.16/ 33/45	Stereo	Articolo	Figura
3750	Garrard	GMC 5	▲			▲		R/1745	
600	Garrard	GMC 5		▲	▲			R/1746	
300	Garrard	GCS 10		▲			▲	R/1747	
390	Garrard	GC 12		▲		▲		R/1747-1	
390	Garrard	GC 12		▲	▲			R/1747-2	
660	Decca	XMS		▲		▲		R/1748	
660	Decca	XMS		▲	▲			R/1749	
300	Electrovoice	14-34		▲		▲		R/1752	
300	Electrovoice	14-34		▲	▲			R/1752-1	
480	Electrovoice	16-TT		▲	▲	▲		R/1753	
480	Electrovoice	EV 21		▲			▲	R/1754	
630	Electrovoice	22-TT		▲	▲	▲		R/1755	

Figura	Articolo	Giradischi	Cartuccia	Dia- mante	Zaffiro	Norm. 78"	L.P.16/ 33/45	Stereo	Prezzo listino
	R/1756	E.M.I. Multiplay			▲		▲		360
	R/1756-1	E.M.I. Multiplay			▲	▲			360
	R/1757	E.M.I.	RS 3		▲		▲		570
	R/1757-1	E.M.I.	RS 3		▲	▲			570
	R/1758	Audak	R 2/R 6		▲		▲		690
	R/1758-1	Audak	R 2/R 6		▲	▲			690
	R/1759	Vaco			▲			▲	270
	R/1760	Webster	WE 14/15		▲		▲		300
	R/1760-1	Webster	WE 14/15		▲	▲			300
	R/1762	Webster	SC 1		◊		▲		360
	R/1762-1	Webster	SC 1		▲	▲			360
	R/1763	Webster	SC 3 SCT 3		▲	▲	▲	▲	900
	R/1767	Zenith Cobra			▲		▲		4200
	R/1768	Zenith Cobra			▲	▲			4200

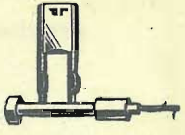
Prezzo listino	Giradischi	Cartuccia	Dia- mante	Zaffiro	Norm. 78"	L.P.16/ 33/45	Stereo	Articolo	Figura
510	Collaro	Ronette TX 88		▲		▲		R/1771	
510	Collaro	Ronette TX 88		▲	▲			R/1772	
376	G.E	RPY RPX		▲		▲		R/1777	
3750	G.E	RPY RPX	▲			▲		R/1779	
376	G.E	RPY RPX		▲	▲			R/1780	
376	G.E	VR II 4G050		▲		▲		R/1781	
3750	G.E	VR II 4G050	▲			▲		R/1782	
376	G.E	VR II 4G050		▲	▲			R/1783	
840	G.E	GC 7		▲			▲	R/1784	
690	G.E	RPX 040		▲		▲		R/1784-3	
690	G.E	RPX 040		▲	▲			R/1784-4	
360	BSR Plessey	} Goldring 200		▲		▲		R/1785	
360	BSR Plessey	} Goldring 200		▲	▲			R/1786	
450	Collaro Garrard	Goldring 500		▲		▲		R/1788	
450	Collaro Garrard	Goldring 500		▲	▲			R/1789	
330	Collaro	PX		▲		▲		R/1790	
330	Collaro	PX		▲	▲			R/1790-1	

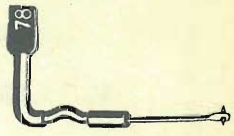
Figura	Articolo	Giradisch	Cartuccia	Dia- mante	Zaffiro	Norm. 78''	L.P.16/ 33/45	Stereo	Prezzo listino
	R/1790-3	Collaro studio	Stereo		▲			▲	500
	R/1791	Garrard Goldring	} Goldring 600-580		▲	▲			1050
	R/1792	Garrard Goldring	} Goldring 600-580		▲		▲		1050
	R/1793	Elac Miratwin			▲		▲		630
	R/1794	Elac Miratwin			▲	▲			630
	R/1795	Garrard Collaro	} Ronette BF 40		▲		▲	▲	300
	R/1795-1	Garrard Collaro	} Ronette BF 40	▲			▲	▲	3750
	R/1796	Garrard Collaro	} Ronette BF 40		▲	▲			300
	R/1797	Sonotone	Stereo		▲			▲	720
	R/1797-1	Sonotone	8 T		▲	▲		▲	570
	R/1797-5	Sonotone	8 TA		▲	▲	▲	▲	600

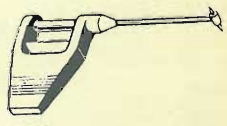
Prezzo listino	Giradischi	Cartuccia	Dia- mante	Zaffiro	Norm. 78"	L.P.16/ 33/45	Stereo	Articolo	Figura
1200	Sonotone	9 T		▲	▲	▲	▲	R/1797-6	
570	Plessey Sonotone	2 T		▲	▲	▲		R/1798	
570	Plessey Sonotone	3 T		▲	▲	▲		R/1799	
800	Sonotone	10 T		▲		▲		R/1799-3	
800	Sonotone	10 T		▲	▲			R/1799-4	
1200	Sonotone	12 T		▲	▲	▲		R/1799-6	
800	Sonotone	S 63		▲		▲		R/1799-8	
800	Sonotone	S 63		▲	▲			R/1799-9	
300	BSR Monarch	} TC 8 H } TC 8		▲		▲		R/1800	
300	BSR Monarch	} TC 8 H } TC 8		▲	▲			R/1800-1	

*Al fine di facilitare l'evasione delle ordinazioni, Vi
preghiamo di attenerVi scrupolosamente a quanto appresso:*

- I. - Scrivete chiaramente il Vostro indirizzo, possibilmente a macchina o in stampatello.**
- II. - Consultate attentamente il Catalogo illustrato e successivi bollettini prima di compilare gli ordini.**
- III. - Indicare SEMPRE il numero di Catalogo.**
- IV. - Non richiedete materiali speciali non compresi nella nostra gamma di vendita.**
- V. - Non ordinate materiali per importi inferiori a L. 5000.**
- VI. - Accompagnate le ordinazioni con un anticipo.**
- VII. - Indirizzare gli ordini al magazzino competente di zona.**

Gian Bruto Castelfranchi

DIREZIONE GENERALE:

Via Petrella, 6 - **MILANO** - Telef. 211.051/5

ORGANIZZAZIONE DI VENDITA:

ANCONA	- Via Vitt. Emanuele, 122	NAPOLI	- Via Cimarosa, 93/A
AVELLINO	- Via Marconi, 143	VOMERO	
BARI	- Via Dante, 5	NAPOLI	- Via C. Porzio, 10a - 10b
BOLOGNA	- Via R. Reno, 62	NAPOLI	- Via Roma, 28/21
BENEVENTO	- C.so Garibaldi, 12	NOVARA	- C.so F. Cavallotti, 40
CIVITANOVA	- C.so Umberto, 77	PALERMO	- P.zza Casteinuovo, 48
CAGLIARI	- Via Rossini, 44	PADOVA	- Via Beldomandi, 1
FIRENZE	- Viale Belfiore, 8r	ROMA	- Via S. Agostino, 14
GENOVA	- P.zza J. da Varagine - da Caricamento	TORINO	- Via Nizza, 34
		UDINE	- Via Div. Julia, 26

LISTINO PREZZI

LUGLIO 1961

PAG. N°	ART. N°	PREZZO LISTINO	PREZZO NETTO	PAG. N°	ART. N°	PREZZO LISTINO	PREZZO NETTO
6	A/1	950		18	A/210	1.350	
6	A/2	1.620		18	A/211	1.600	
6	A/3	1.620		—	A/211-1	2.400	
7	A/4	2.750		18	A/212	2.900	
7	A/101	1.200		—	A/212-1	3.800	
7	A/102	1.200		18	A/213	3.000	
8	A/103	1.750		—	A/213-1	4.000	
8	A/104	2.100		19	A/214	2.250	
8	A/105	3.250		—	A/214-1	2.500	
9	A/106	4.350		—	A/214-2	1.800	
9	A/107	5.100		—	A/214-3	2.200	
9	A/108	17.500		—	A/214-4	2.300	
10	A/109	20.000		19	A/215	2.700	
10	A/110	31.000		—	A/215-1	2.000	
11	A/111	2.200		—	A/215-2	2.500	
11	A/112	1.150		19	A/216	13.500	
11	A/113	1.450		20	A/217	11.500	
12	A/114	2.100		20	A/218	14.800	
12	A/115	3.000		20	A/219	23.500	
12	A/116	1.600		21	A/220	11.000	
13	A/117	2.500		—	A/220-2	1.600	
13	A/118	2.850		—	A/220-3	1.900	
13	A/119	3.650		—	A/220-4	2.100	
14	A/120	2.350		21	A/221	12.500	
14	A/121	4.250		—	A/221-1	2.200	
14	A/122	26.000		21	A/222	14.000	
—	A/131	2.200		—	A/222-1	2.300	
—	A/132	3.700		—	A/222-2	2.600	
15	A/201	1.200		22	A/223	9.800	
15	A/202	1.250		—	A/223-1	5.600	
—	A/202-1	1.350		—	A/223-3	2.000	
—	A/202-2	1.500		—	A/223-4	2.100	
—	A/202-3	1.400		22	A/224	9.800	
—	A/202-4	1.500		—	A/224-1	2.300	
—	A/202-5	1.600		—	A/224-2	2.500	
—	A/202-6	1.700		22	A/225	23.000	
—	A/202-7	1.900		—	A/225-1	2.700	
—	A/202-8	2.100		—	A/225-2	2.700	
—	A/202-9	2.250		—	A/225-3	2.500	
15	A/203	2.800		—	A/225-4	2.600	
—	A/206-1	2.400		23	A/226	3.100	
—	A/206-2	2.300		23	A/227	1.800	
—	A/207-1	2.400		23	A/228	1.250	
17	A/209	2.450		—	A/230	11.500	

PAG. N°	ART. N°	PREZZO LISTINO	PREZZO NETTO	PAG. N°	ART. N°	PREZZO LISTINO	PREZZO NETTO
—	A/231	13.000		34	A/435	1.750	
—	A/232	15.500		35	A/436	1.650	
—	A/233	24.500		—	A/436-1	1.680	
—	A/240	14.000		—	A/436-2	1.800	
—	A/241	16.000		35	A/437	1.500	
—	A/242	25.000		35	A/438-1	1.900	
25	A/301	890		36	A/439	2.000	
25	A/302	910		36	A/440	1.900	
25	A/303	1.150		36	A/441	2.400	
26	A/304	1.300		—	A/441-1	2.400	
26	A/305	2.200		37	A/442	3.300	
26	A/306	1.350		37	A/443	3.300	
27	A/307	1.500		—	A/443-1	2.700	
27	A/401	3.600		37	A/444	5.000	
27	A/402	4.350		38	A/451	3.100	
28	A/411	3.300		38	A/452	3.850	
28	A/412	1.650		38	A/453	4.900	
28	A/413	1.950		39	A/454	5.400	
29	A/414	2.060		39	A/455	5.900	
29	A/415	2.000		39	A/456	6.500	
29	A/416	10.500		40	A/457	8.100	
30	A/421	1.200		40	A/458	9.100	
30	A/422	1.500		41	A/460	12.200	
30	A/423	1.650		41	A/461	5.500	
31	A/424	1.800		41	A/462	6.600	
31	A/425	2.300		42	A/463	3.900	
31	A/426	3.300		42	A/464	17.800	
32	A/427	6.000		43	A/465	28.700	
32	A/428	1.400		43	A/466	36.700	
32	A/429	1.650		43	A/467	41.000	
—	A/429-1	1.900		43	A/468	71.500	
—	A/429-2	2.600		44	A/469	9.800	
33	A/430	1.650		44	A/470	44.500	
—	A/430-2	1.300		44	A/471	56.000	
—	A/430-3	1.550		45	A/473	6.000	
—	A/430-4	1.680		45	A/474	15.400	
—	A/430-5	1.800		46	A/475	15.900	
—	A/430-6	2.300		46	A/476	6.200	
—	A/430-7	1.800		46	A/477	8.200	
—	A/430-8	2.300		47	A/478	24.000	
33	A/431	2.000		47	A/479	30.000	
33	A/432	2.500		—	A/479-1	20.200	
34	A/433	3.800		—	A/479-2	20.200	
34	A/434	1.500		—	A/479-3	11.900	

PAG. N°	ART. N°	PREZZO LISTINO	PREZZO NETTO	PAG. N°	ART. N°	PREZZO LISTINO	PREZZO NETTO
48	A/480	69.000		—	A/664	25.000	
48	A/481	89.000		—	A/671	1.750	
48	A/482	32.000		—	A/672	1.750	
—	A/483	44.000		—	A/673	1.750	
49	A/485	38.000					
—	A/485-1	43.000			B		
—	A/494	6.000					
—	A/495	8.200		58	B/1	2.300	
—	A/496	18.200		58	B/2	2.300	
—	A/497	13.200		58	B/3	2.300	
—	A/498	12.300		58	B/4	2.300	
—	A/499	12.900		59	B/11	34	
—	A/500	19.400		59	B/12	38	
52	A/522	1.650		59	B/15	36	
52	A/531	5.700		59	B/16	38	
53	A/561	1.400		59	B/17	56	
53	A/562	2.000		—	B/21	108	
53	A/563	2.500		—	B/21-1	42	
53	A/564	3.000		—	B/21-2	42	
53	A/571	1.000		—	B/21-3	42	
53	A/572	1.400		—	B/21-4	56	
53	A/573	1.600		—	B/21-5	56	
53	A/574	2.150		—	B/21-6	66	
54	A/592	—		—	B/21-7	66	
54	A/593	—		—	B/22	260	
54	A/594	—		—	B/25	34	
54	A/595	—		—	B/25-2	34	
54	A/596	—		—	B/26	30	
54	A/597	—		—	B/26-1	30	
55	A/610	—		—	B/26-2	30	
55	A/611	—		—	B/27	36	
55	A/612	—		—	B/27-1	36	
55	A/613	—		—	B/27-2	36	
55	A/614	—		—	B/28	44	
56	A/620	—		—	B/28-1	44	
56	A/621	—		—	B/28-2	44	
56	A/622	—		—	B/29	50	
—	A/625	15.400		—	B/29-1	50	
—	A/640	14.400		—	B/29-2	50	
—	A/641	25.700		—	B/30	54	
—	A/642	11.700		—	B/30-1	54	
—	A/644	21.200		—	B/30-2	54	
—	A/660	9.250		—	B/31	66	
—	A/662	15.400		—	B/31-1	66	

PAG. N°	ART. N°	PREZZO LISTINO	PREZZO NETTO	PAG. N°	ART. N°	PREZZO LISTINO	PREZZO NETTO
—	B/31-2	66		—	B/36-6	62	
—	B/32	76		—	B/36-7	72	
—	B/32-1	76		—	B/36-8	72	
—	B/32-2	76		—	B/37	36	
—	B/33	80		—	B/37-1	36	
—	B/33-1	80		—	B/37-2	36	
—	B/33-2	80		—	B/37-3	36	
—	B/33-4	44		—	B/37-4	36	
—	B/33-5	50		—	B/37-5	36	
—	B/33-6	54		—	B/37-6	36	
—	B/33-7	64		—	B/37-8	36	
—	B/33-8	76		—	B/37-9	40	
—	B/33-9	80		—	B/38	40	
—	B/34	44		—	B/38-1	40	
—	B/34-1	44		—	B/38-2	40	
—	B/34-2	50		—	B/38-3	50	
—	B/34-3	54		—	B/38-4	50	
—	B/34-5	64		—	B/38-5	50	
—	B/34-6	76		—	B/38-6	68	
—	B/34-7	80		—	B/38-7	68	
—	B/34-8	34		—	B/38-8	68	
—	B/34-9	44		—	B/39-1	68	
—	B/34-11	44		—	B/39-3	72	
—	B/34-12	44		—	B/39-5	74	
—	B/34-13	50		—	B/39-7	84	
—	B/34-14	54		—	B/39-9	114	
—	B/34-15	64		—	B/40	36	
—	B/34-16	76		—	B/40-1	36	
—	B/34-17	80		—	B/40-2	36	
—	B/35	34		—	B/40-3	42	
—	B/35-1	34		—	B/40-4	48	
—	B/35-2	34		—	B/40-5	48	
—	B/35-3	36		—	B/41	36	
—	B/35-4	38		—	B/41-1	36	
—	B/35-5	38		—	B/41-2	36	
—	B/35-6	40		—	B/41-3	46	
—	B/35-7	44		—	B/41-4	46	
—	B/35-8	46		—	B/42	72	
—	B/36	42		—	B/42-1	94	
—	B/36-1	42		—	B/42-2	114	
—	B/36-2	46		—	B/42-3	188	
—	B/36-3	52		—	B/42-4	292	
—	B/36-4	58		—	B/43	72	
—	B/36-5	62		—	B/43-1	94	

PAG. N°	ART. N°	PREZZO LISTINO	PREZZO NETTO	PAG. N°	ART. N°	PREZZO LISTINO	PREZZO NETTO
—	B/43-2	104		60	B/89	180	
—	B/43-3	156		60	B/90	210	
—	B/54	58		60	B/91	260	
—	B/56	90		60	B/92	290	
—	B/76-1	42		60	B/93	330	
—	B/76-2	40		60	B/94	360	
—	B/76-3	40		60	B/95	390	
—	B/76-4	34		60	B/125	80	
—	B/76-5	34		60	B/126	90	
—	B/76-6	30		60	B/127	100	
—	B/76-7	30		60	B/128	120	
59	B/77	30		—	B/128-1	130	
—	B/77-1	30		60	B/129	200	
—	B/77-2	30		—	B/129-1	220	
59	B/78	30		60	B/130	260	
—	B/78-1	30		—	B/130-1	270	
59	B/79	34		60	B/131	390	
—	B/79-1	34		—	B/131-1	390	
—	B/79-2	34		—	B/131-2	420	
—	B/79-3	34		—	B/131-3	440	
—	B/79-4	40		60	B/132	590	
—	B/79-5	40		—	B/132-1	620	
—	B/79-6	40		—	B/132-2	640	
—	B/79-7	50		—	B/132-3	660	
59	B/80	50		60	B/133	680	
—	B/80-1	60		—	B/133-1	690	
—	B/80-2	70		—	B/133-2	720	
—	B/80-3	86		60	B/134	740	
—	B/80-4	140		—	B/134-1	760	
—	B/80-5	162		—	B/134-2	780	
—	B/80-6	212		60	B/141	30	
60	B/81	40		—	B/141-1	34	
60	B/82	48		—	B/141-2	36	
60	B/83	58		—	B/141-3	40	
—	B/83-1	58		60	B/142	40	
60	B/84	62		—	B/142-1	46	
60	B/85	76		—	B/142-2	48	
—	B/85-1	76		60	B/143	54	
—	B/85-2	80		—	B/143-1	60	
—	B/85-3	80		—	B/143-2	68	
—	B/85-4	90		—	B/160	40	
60	B/86	110		—	B/161	40	
60	B/87	120		—	B/162	40	
60	B/88	150		—	B/165	40	

PAG. N°	ART. N°	PREZZO LISTINO	PREZZO NETTO	PAG. N°	ART. N°	PREZZO LISTINO	PREZZO NETTO
—	B/166	40		62	B/244	50	
—	B/167	40		62	B/245	56	
—	B/168	40		62	B/246	82	
—	B/169	40		—	B/246-1	100	
—	B/170	48		62	B/247	106	
—	B/171	54		62	B/248	166	
—	B/172	60		62	B/252	36	
—	B/173	68		62	B/253	36	
—	B/174	76		62	B/254	36	
61	B/181	62		62	B/255	36	
61	B/182	62		62	B/256	38	
61	B/183	62		62	B/257	40	
—	B/183-1	62		62	B/258	44	
61	B/184	70		62	B/260	50	
61	B/185	78		62	B/261	60	
61	B/186	84		62	B/262	70	
61	B/187	88		62	B/263	110	
61	B/188	98		62	B/264	180	
61	B/189	130		62	B/271	170	
61	B/190	170		62	B/272	170	
61	B/191	230		62	B/273	170	
61	B/201	38		62	B/274	170	
—	B/201-1	38		62	B/275	200	
—	B/201-2	38		62	B/276	210	
61	B/202	38		62	B/277	220	
—	B/202-1	38		62	B/278	230	
61	B/203	46		62	B/279	270	
—	B/203-1	56		62	B/280	300	
61	B/204	64		62	B/281	480	
—	B/204-1	66		—	B/285	240	
61	B/205	76		—	B/286	240	
61	B/206	100		—	B/287	240	
—	B/207-1	168		—	B/288	240	
61	B/208	178		—	B/289	320	
61	B/227	250		—	B/291	240	
61	B/228	260		—	B/295	150	
61	B/229	270		—	B/296	150	
61	B/230	296		—	B/297	160	
61	B/231	340		64	B/321	130	
—	B/232	518		64	B/322	130	
—	B/233	586		64	B/323	130	
62	B/241	50		64	B/324	130	
62	B/242	50		64	B/325	138	
62	B/243	50		64	B/326	106	

PAG. Nº	ART. Nº	PREZZO LISTINO	PREZZO NETTO	PAG. Nº	ART. Nº	PREZZO LISTINO	PREZZO NETTO
64	B/327	120		65	B/389	320	
64	B/331	130		65	B/390	570	
64	B/331-1	130		65	B/404	148	
64	B/331-2	130		—	B/405-1	850	
64	B/331-3	106		65	B/406	80	
64	B/333	106		65	B/407	120	
64	B/334-1	120		65	B/408	130	
64	B/335	130		65	B/409	190	
64	B/336-1	130		65	B/410	280	
64	B/337-1	130		65	B/412	96	
64	B/337-2	106		65	B/414	180	
64	B/338-1	120		65	B/415	98	
64	B/339-1	130		—	B/417-1	320	
—	B/339-2	150		65	B/418	230	
—	B/339-3	180		66	B/461	168	
—	B/339-4	130		66	B/462	280	
—	B/341-1	138		66	B/463	460	
64	B/343	106		66	B/464	300	
—	B/345	120		66	B/465	510	
—	B/346	126		66	B/466	830	
—	B/347	150		66	B/467	166	
—	B/348	180		66	B/468	230	
65	B/361	82		66	B/469	350	
65	B/362	98		66	B/470	470	
65	B/363	116		66	B/471	280	
65	B/364	176		66	B/472	395	
65	B/365	250		66	B/473	578	
65	B/371	90		66	B/474	720	
65	B/372	98		66	B/475	790	
65	B/373	116		66	B/476	240	
65	B/374	176		66	B/477	390	
65	B/375	250		66	B/478	590	
—	B/376	278		66	B/479	430	
—	B/377	300		66	B/480	520	
—	B/380	112		66	B/481	580	
65	B/381	124		67	B/501	148	
—	B/381-1	150		67	B/502	326	
65	B/382	172		—	B/502-1	530	
65	B/383	230		67	B/503	290	
65	B/384	390		67	B/503-1	476	
65	B/385	128		67	B/503-2	500	
65	B/386	140		67	B/504	890	
65	B/387	170		67	B/505	960	
65	B/388	240		67	B/505-1	150	

PAG. N°	ART. N°	PREZZO LISTINO	PREZZO NETTO	PAG. N°	ART. N°	PREZZO LISTINO	PREZZO NETTO
67	B/506	250		68	B/566	210	
67	B/507	226		68	B/567	250	
67	B/508	288		68	B/568	270	
67	B/509	370		68	B/569	390	
67	B/510	350		68	B/570	420	
67	B/511	400		68	B/571	650	
67	B/512	460		68	B/572	630	
67	B/513	570		68	B/573	290	
67	B/514	650		68	B/574	290	
67	B/514-1	810		68	B/575	550	
67	B/514-2	790		—	B/575-1	600	
67	B/515	890		68	B/576	230	
—	B/515-1	1.050		68	B/577	390	
67	B/516	1.050		69	B/601	156	
67	B/516-1	130		69	B/602	290	
67	B/516-2	210		69	B/621	154	
67	B/517	250		69	B/622	320	
67	B/518	390		69	B/623	330	
67	B/518-1	420		69	B/624	260	
67	B/518-2	530		69	B/625	360	
67	B/518-3	510		69	B/626	320	
67	B/518-4	880		69	B/627	540	
—	B/518-6	590		69	B/628	580	
67	B/519	290		69	B/629	750	
67	B/520	290		69	B/641	164	
67	B/521	290		69	B/642	280	
68	B/522	220		69	B/643	260	
68	B/551	148		69	B/644	370	
68	B/552	326		70	B/661	250	
68	B/553	310		70	B/662	440	
68	B/554	390		—	B/662-1	490	
68	B/555	550		70	B/663	440	
68	B/556	530		70	B/664	650	
68	B/556-1	850		70	B/665	630	
68	B/556-2	990		70	B/666	950	
68	B/557	150		70	B/667	1.000	
68	B/558	298		70	B/668	1.000	
68	B/559	240		70	B/669	230	
68	B/560	370		70	B/670	350	
68	B/561	350		70	B/671	330	
68	B/562	490		70	B/672	510	
68	B/563	650		70	B/673	490	
68	B/564	890		70	B/673-1	500	
68	B/565	870		70	B/674	750	

PAG. N°	ART. N°	PREZZO LISTINO	PREZZO NETTO	PAG. N°	ART. N°	PREZZO LISTINO	PREZZO NETTO
70	B/675	950		71	B/733	420	
70	B/676	930		71	B/734	620	
—	B/676-1	1.130		71	B/735	940	
70	B/677	500		71	B/736	1.150	
70	B/678	580		71	B/737	1.250	
70	B/679	680		71	B/751	660	
70	B/680	720		—	B/751-1	590	
—	B/685	590		—	B/751-2	690	
70	B/691	750		—	B/751-3	740	
70	B/692	950		—	B/751-4	850	
70	B/693	950		71	B/752	490	
70	B/694	950		71	B/754	490	
70	B/695	1.250		71	B/755	740	
—	B/696	240		—	B/756	650	
—	B/696-1	430		—	B/757	630	
—	B/697	640		—	B/758	790	
—	B/698	610		—	B/759	990	
—	B/698-1	900		71	B/761	1.050	
—	B/699	970		71	B/762	1.150	
—	B/701	970		—	B/768	850	
—	B/701-1	350		72	B/771	1.200	
—	B/701-2	320		72	B/772	1.750	
—	B/701-3	500		72	B/773	2.700	
—	B/701-4	480		72	B/781	750	
—	B/701-5	720		72	B/782	790	
—	B/702	900		72	B/783	1.150	
—	B/702-1	560		72	B/784	1.250	
—	B/703	690		72	B/785	1.300	
70	B/711	10		72	B/786	1.850	
70	B/712	10		72	B/787	2.250	
70	B/715	10		72	B/788	2.450	
70	B/716	10		72	B/789	950	
71	B/721	330		72	B/790	1.550	
71	B/722	620		72	B/791	2.100	
71	B/723	720		72	B/792	2.700	
71	B/724	430		72	B/793	2.900	
71	B/725	650		72	B/801	1.980	
71	B/726	820		72	B/802	2.480	
71	B/727	880		72	B/803	2.980	
71	B/728	1.040		72	B/804	3.240	
71	B/729	250		—	B/805	3.500	
71	B/730	370		72	B/811	900	
71	B/731	570		72	B/812	890	
71	B/732	950		73	B/821	1.150	

PAG. N°	ART. N°	PREZZO LISTINO	PREZZO NETTO	PAG. N°	ART. N°	PREZZO LISTINO	PREZZO NETTO
73	B/822	1.350		75	B/916	2.200	
73	B/823	850		75	B/917	2.500	
73	B/824	950		75	B/918	3.100	
73	B/825	1.150		75	B/919	3.500	
73	B/826	950		75	B/920	4.200	
73	B/827	1.000		75	B/921	4.600	
73	B/828	1.200		76	B/951	490	
73	B/829	1.100		76	B/952	640	
73	B/830	1.300		76	B/953	1.080	
74	B/861	2.150		76	B/954	1.080	
74	B/862	2.550		76	B/955	1.080	
74	B/863	3.350		76	B/961	3.900	
74	B/864	3.980		76	B/962	3.900	
74	B/865	1.400		76	B/963	3.900	
74	B/866	2.000					
74	B/867	2.500			C		
74	B/868	3.100					
74	B/869	1.350		78	C/3	70	
74	B/870	1.650		—	C/8	64	
74	B/871	590		—	C/9	58	
74	B/872	740		78	C/10	78	
75	B/880	1.250		78	C/11	88	
75	B/881	1.450		78	C/12	88	
75	B/882	1.750		78	C/13	82	
75	B/883	2.200		78	C/14	94	
75	B/884	2.300		—	C/16	360	
75	B/885	2.500		—	C/17	140	
75	B/886	3.200		—	C/18	98	
75	B/887	3.700		79	C/51	22	
75	B/901	1.500		79	C/52	28	
75	B/902	1.600		79	C/53	36	
75	B/903	1.900		79	C/61	56	
75	B/904	2.200		79	C/71	150	
75	B/905	2.600		79	C/83	38	
75	B/906	2.900		79	C/91	60	
75	B/907	3.600		79	C/95	166	
75	B/908	1.600		79	C/96	170	
75	B/909	1.700		79	C/98	42	
75	B/910	2.200		79	C/99	56	
75	B/911	2.500		80	C/101	46	
75	B/912	2.800		80	C/102	56	
75	B/913	3.500		80	C/103	100	
75	B/914	4.600		80	C/104	146	
75	B/915	1.500		80	C/105	50	

PAG. N°	ART. N°	PREZZO LISTINO	PREZZO NETTO	PAG. N°	ART. N°	PREZZO LISTINO	PREZZO NETTO
80	C/106	50		82	C/221	120	
80	C/107	84		82	C/222	120	
—	C/108	160		82	C/222-1	120	
—	C/109	86		82	C/223	150	
80	C/111	46		82	C/224	150	
80	C/112	58		82	C/225	150	
80	C/121	24		82	C/231	210	
—	C/129-1	100		82	C/232	210	
—	C/129-2	164		82	C/232-1	210	
—	C/130	14		82	C/233	250	
—	C/130-1	120		82	C/234	250	
—	C/130-2	174		82	C/235	250	
80	C/131	12		82	C/251	210	
80	C/132	14		82	C/252	210	
80	C/136	28		82	C/252-1	210	
—	C/136-1	38		82	C/253	250	
80	C/141	264		82	C/254	250	
80	C/142	408		82	C/255	250	
80	C/143	418		—	C/260	290	
80	C/144	506		—	C/262	290	
80	C/151	2.400		83	C/281	2.950	
80	C/152	2.400		84	C/301	8	
80	C/153	2.400		84	C/302	10	
81	C/171	18		84	C/303	12	
81	C/172	26		84	C/304	14	
81	C/173	18		84	C/305	16	
81	C/174	26		84	C/306	20	
81	C/181	34		84	C/307	22	
81	C/182	48		84	C/308	32	
81	C/191	4		84	C/309	40	
81	C/192	6		84	C/310	44	
81	C/193	8		84	C/311	48	
81	C/194	10		84	C/312	60	
81	C/195	14		84	C/351	32	
—	C/196	144		84	C/352	36	
—	C/197	156		84	C/353	42	
—	C/198	180		84	C/354	48	
—	C/199	206		84	C/355	52	
—	C/200	230		84	C/356	60	
81	C/201	33		84	C/357	70	
81	C/202	44		84	C/358	80	
81	C/203	52		—	C/358-1	94	
81	C/204	74		—	C/358-2	108	
81	C/205	94		—	C/358-3	128	

PAG. N°	ART. N°	PREZZO LISTINO	PREZZO NETTO	PAG. N°	ART. N°	PREZZO LISTINO	PREZZO NETTO
—	C/358-4	144		—	D/66-7	66	
84	C/359	170		—	D/67	28	
—	C/360	72		—	D/67-2	32	
	D			—	D/68	30	
86	D/1	1.700		—	D/68-2	34	
86	D/11	2.350		—	D/68-4	56	
87	D/2	1.700		—	D/68-5	66	
86	D/12	5.800		—	D/69	30	
87	D/22	2.350		—	D/69-2	34	
87	D/23	5.800		—	D/69-4	60	
88	D/3	2.000		—	D/69-5	70	
88	D/13	2.250		—	D/70	42	
88	D/4	2.000		—	D/70-2	50	
88	D/14	2.250		91	D/71	38	
89	D/31	60		91	D/72	54	
89	D/32	18		91	D/73	72	
89	D/33	16		91	D/74	88	
90	D/41	100		91	D/75	100	
90	D/42	28		91	D/76	120	
90	D/43	24		91	D/77	130	
90	D/51	200		91	D/78	150	
90	D/52	100		91	D/79	250	
90	D/53	80		—	D/80	440	
—	D/54	250		—	D/85	120	
—	D/54-1	230		—	D/86	150	
—	D/54-2	240		—	D/87	250	
—	D/54-3	270		92	D/91	430	
—	D/54-4	340		92	D/92	510	
91	D/56	310		—	D/92-1	550	
91	D/57	310		92	D/93	570	
91	D/58	1.550		92	D/94	630	
—	D/59	32		92	D/95	850	
—	D/60	270		92	D/96	1.150	
—	D/60-1	810		92	D/97	1.300	
91	D/64	30		92	D/101	750	
—	D/65	60		92	D/102	1.350	
—	D/65-2	74		92	D/103	1.550	
—	D/66	38		92	D/104	1.650	
—	D/66-2	44		92	D/105	2.500	
—	D/66-4	28		—	D/130	650	
—	D/66-5	34		—	D/131	1.400	
—	D/66-6	56		—	D/135	1.400	
				—	D/136	1.400	
				—	D/141	680	

PAG. N°	ART. N°	PREZZO LISTINO	PREZZO NETTO	PAG. N°	ART. N°	PREZZO LISTINO	PREZZO NETTO
—	D/142	680		94	D/223	470	
—	D/143	650		95	D/231	470	
—	D/146	130		95	D/232	470	
—	D/147	130		—	D/232-1	1.000	
—	D/148	130		95	D/233	470	
—	D/149	130		—	D/235	360	
—	D/150	750		—	D/236	360	
93	D/151	190		—	D/237	460	
93	D/161	210		—	D/238	460	
93	D/162	210		—	D/239	510	
93	D/171	220		95	D/241	290	
93	D/172	220		—	D/241-1	330	
93	D/181	230		95	D/242	380	
93	D/182	230		95	D/243	290	
93	D/191	300		—	D/243-1	270	
93	D/192	300		—	D/243-2	330	
—	D/192-5	90		95	D/244	380	
—	D/192-6	320		—	D/244-1	290	
—	D/192-7	320		95	D/251	380	
—	D/192-8	500		95	D/252	500	
—	D/192-9	500		95	D/253	380	
—	D/193	150		95	D/254	500	
—	D/194	160		95	D/255	500	
—	D/194-1	190		95	D/256	500	
—	D/195	190		95	D/257	500	
94	D/196	200		—	D/260	1.150	
—	D/197	250		—	D/261	1.150	
94	D/201	370		96	D/271	880	
94	D/202	370		96	D/272	960	
—	D/203	480		96	D/273	1.030	
—	D/204	480		96	D/274	1.080	
—	D/206	520		97	D/275	1.180	
—	D/207	520		97	D/276	1.230	
94	D/211	250		97	D/281	320	
—	D/211-2	330		97	D/282	320	
—	D/211-4	360		97	D/291	930	
94	D/212	250		97	D/292	1.080	
—	D/212-2	330		—	D/292-1	1.150	
94	D/213	340		98	D/293	830	
94	D/221	380		98	D/294	930	
—	D/221-2	440		98	D/301	750	
—	D/221-4	460		99	D/311	860	
94	D/222	380		99	D/312	860	
—	D/222-1	440		99	D/314	960	

PAG. N°	ART. N°	PREZZO LISTINO	PREZZO NETTO	PAG. N°	ART. N°	PREZZO LISTINO	PREZZO NETTO
99	D/316	1.080		—	D/380-2	4.100	
99	D/317	1.180		—	D/380-3	4.350	
99	D/321	1.080		101	D/381	5.000	
—	D/321-1	1.100		101	D/382	5.100	
99	D/322	1.180		101	D/383	5.600	
—	D/322-1	1.200		101	D/391	6.600	
99	D/323	1.280		101	D/392	6.950	
99	D/331	840		101	D/393	7.300	
99	D/332	840		101	D/394	7.600	
—	D/333	1.080		101	D/396	11.700	
—	D/334	1.100		101	D/397	12.500	
100	D/341	1.250		101	D/398	13.500	
100	D/342	1.350		101	D/399	14.500	
100	D/344	1.450		101	D/400	15.500	
100	D/351	1.550		102	D/411	170	
100	D/352	1.650		102	D/412	200	
100	D/353	1.750		102	D/413	250	
100	D/354	1.850		102	D/414	250	
100	D/355	1.950		102	D/415	250	
100	D/356	2.000		102	D/416	250	
100	D/357	2.350		102	D/417	380	
—	D/358	1.700		102	D/418	250	
—	D/359	1.800		102	D/419	380	
—	D/359-1	1.900					
—	D/359-2	2.000					
—	D/360	2.100			E		
100	D/361	1.950		104	E/1	800	
100	D/362	2.100		104	E/2	710	
100	D/363	2.200		104	E/2-1	1.050	
100	D/364	2.300		104	E/3	1.150	
100	D/365	2.400		104	E/4	970	
100	D/366	2.500		104	E/4-1	1.450	
100	D/367	2.600		104	E/5	1.200	
100	D/371	4.400		104	E/6	1.000	
100	D/372	4.500		104	E/6-1	1.500	
100	D/373	4.700		104	E/7	1.480	
100	D/374	4.800		104	E/8	1.250	
100	D/375	4.900		104	E/8-1	1.880	
—	D/376	4.500		104	E/9	1.590	
—	D/377	4.750		104	E/10	1.330	
—	D/378	4.850		105	E/10-1	1.980	
—	D/379	4.950		105	E/11	2.050	
—	D/380	5.100		105	E/12	1.780	
—	D/380-1	3.800					

PAG. N°	ART. N°	PREZZO LISTINO	PREZZO NETTO	PAG. N°	ART. N°	PREZZO LISTINO	PREZZO NETTO
105	E/12-1	2.650		—	E/81-1	666	
105	E/13	2.180		112	E/82-1	750	
105	E/14	2.850		112	E/83-1	550	
105	E/14-1	2.850		—	E/83-2	660	
105	E/15	2.900		112	E/84	620	
105	E/16	2.490		112	E/86-1	950	
105	E/16-1	3.750		112	E/87	750	
105	E/17	3.100		112	E/88	1.190	
105	E/18	2.650		113	E/89-1	950	
105	E/19	3.900		113	E/90-1	1.250	
107	E/21	580		113	E/91-1	1.350	
107	E/22	670		113	E/92	970	
107	E/23	690		—	E/92-1	1.400	
107	E/24	780		113	E/93	1.080	
108	E/25	870		—	E/93-1	700	
108	E/26	780		—	E/93-2	1.350	
108	E/28	1.000		113	E/94	1.290	
108	E/29	1.250		113	E/95	1.380	
108	E/51	620		—	E/95-1	2.900	
108	E/52	700		113	E/96	1.050	
108	E/53	750		114	E/111-1	1.290	
109	E/54	370		114	E/112-1	1.940	
109	E/55	450		114	E/114-1	1.830	
109	E/56	690		—	E/114-2	2.820	
109	E/57	1.280		114	E/115	1.750	
109	E/58	700		—	E/116	2.600	
109	E/59	820		—	E/117	2.800	
109	E/60	1.280		114	E/122	2.950	
109	E/60-1	2.400		114	E/123	3.000	
—	E/60-2	466		—	E/126	2.600	
110	E/61	470		—	E/127	3.150	
110	E/62	560		—	E/128	3.600	
110	E/62-1	560					
110	E/63	560			F		
110	E/64	590					
110	E/64-1	610		116	F/1	150	
110	E/64-2	660		116	F/2	136	
111	E/64-3	690		116	F/4	230	
111	E/64-4	760		116	F/5	150	
111	E/64-5	730		116	F/6	380	
111	E/65	810		116	F/7	780	
111	E/66	890		117	F/12	230	
—	E/70	690		117	F/13	200	

PAG. N°	ART. N°	PREZZO LISTINO	PREZZO NETTO	PAG. N°	ART. N°	PREZZO LISTINO	PREZZO NETTO
117	F/14	140		—	F/59-7	90	
117	F/15	140		—	F/59-8	100	
117	F/16	190		—	F/59-9	90	
117	F/17	160		—	F/60	90	
117	F/18	160		—	F/60-1	100	
117	F/19	240		—	F/60-2	110	
117	F/20	136		—	F/60-3	100	
117	F/21	240		—	F/60-4	76	
117	F/22	240		—	F/60-5	86	
117	F/23	240		—	F/60-6	76	
118	F/31	76		120	F/61	160	
118	F/32	200		120	F/62	184	
118	F/33	300		120	F/63	186	
118	F/34	330		120	F/64	50	
118	F/35	66		120	F/65	56	
118	F/36	60		120	F/66	50	
118	F/37	72		120	F/67	56	
118	F/38	62		120	F/68	140	
118	F/39	90		—	F/68-1	140	
118	F/40	90		120	F/69	120	
118	F/43	218		—	F/69-1	120	
118	F/44	184		120	F/70	138	
—	F/45	200		120	F/71	154	
119	F/51	130		120	F/72	154	
119	F/51-1	130		120	F/73	214	
119	F/52	120		120	F/74	204	
—	F/53-1	82		120	F/75	204	
—	F/53-2	82		121	F/76	96	
119	F/54	200		121	F/77	118	
119	F/55	346		121	F/78	118	
119	F/56	130		121	F/79	98	
—	F/56-1	326		121	F/80	96	
—	F/56-2	376		121	F/81	118	
—	F/56-3	462		121	F/82	180	
119	F/57	276		121	F/83	150	
119	F/58	400		121	F/84	150	
—	F/58-1	90		121	F/85	102	
—	F/58-2	86		121	F/86	96	
—	F/59	86		121	F/87	96	
—	F/59-1	86		—	F/87-1	478	
—	F/59-2	90		121	F/88	102	
—	F/59-3	86		—	F/88-1	200	
—	F/59-4	86		121	F/89	130	

PAG. N°	ART. N°	PREZZO LISTINO	PREZZO NETTO	PAG. N°	ART. N°	PREZZO LISTINO	PREZZO NETTO
—	F/89-1	186		125	F/131	46	
121	F/90	130		126	F/132	82	
—	F/90-1	186		126	F/133	82	
122	F/91	122		126	F/134	92	
122	F/92	122		126	F/135	92	
122	F/93	122		126	F/136	42	
122	F/94	150		126	F/137	42	
122	F/95	96		126	F/138	42	
122	F/96	96		126	F/139	60	
—	F/96-1	130		126	F/140	60	
—	F/96-2	190		126	F/141	60	
122	F/97	610		126	F/142	72	
122	F/97-1	168		126	F/143	72	
122	F/97-2	168		126	F/144	72	
122	F/97-3	168		126	F/149	72	
—	F/97-4	160		127	F/153	86	
—	F/97-5	180		127	F/153-1	86	
—	F/99-1	130		127	F/154	60	
—	F/99-2	200		127	F/154-1	60	
123	F/100	194		127	F/155	166	
123	F/100-1	78		127	F/156	166	
123	F/100-2	172		127	F/161	42	
123	F/100-3	118		127	F/162	26	
123	F/100-4	96		127	F/163	26	
123	F/100-5	82		128	F/164	36	
124	F/109	36		128	F/165	32	
124	F/110	78		—	F/167	190	
124	F/111	86		—	F/168	166	
124	F/112	40		128	F/171	40	
124	F/113	76		128	F/172	88	
124	F/114	76		128	F/173	72	
125	F/115	98		128	F/174	72	
125	F/116	146		128	F/175	88	
—	F/117	66		128	F/176	82	
125	F/119	40		128	F/177	78	
125	F/121	62		128	F/178	78	
125	F/122	62		129	F/179	88	
125	F/123	62		129	F/181	68	
—	F/125	76		129	F/182	68	
125	F/126	62		—	F/183	62	
125	F/127	72		129	F/184	16	
—	F/128	120		129	F/185	56	
125	F/130	40		129	F/186	38	

PAG. N°	ART. N°	PREZZO LISTINO	PREZZO NETTO	PAG. N°	ART. N°	PREZZO LISTINO	PREZZO NETTO
129	F/187	40		—	F/324	1.540	
—	F/191	56		—	F/326	1.540	
—	F/192	26		—	F/328	2.420	
609	F/195	96		—	F/330	2.420	
—	F/195-1	100		—	F/332	2.420	
609	F/196	98		—	F/334	2.420	
—	F/196-1	102		—	F/350	1.000	
609	F/197	102		—	F/352	946	
—	F/197-1	110		—	F/354	1.150	
609	F/198	102		—	F/356	946	
—	F/198-1	110		—	F/358	946	
—	F/201	300		—	F/360	630	
—	F/205	300		—	F/362	630	
—	F/207	400		—	F/364	850	
—	F/211-1	200		—	F/370	3.750	
—	F/212	428		—	F/372	4.750	
—	F/213	126		—	F/374	4.100	
—	F/214	76		—	F/376	2.200	
—	F/250	330		—	F/378	3.026	
—	F/252	386		—	F/390	150	
—	F/254	600		—	F/392	158	
—	F/256	630		—	F/396	166	
—	F/258	936		—	F/398	216	
—	F/260	936		—	F/400	216	
—	F/262	1.266		—	F/402	216	
—	F/264	1.266		—	F/404	220	
—	F/266	1.266		—	F/406	270	
—	F/268	1.760		—	F/408	230	
—	F/270	1.760		—	F/410	260	
—	F/272	1.760		—	F/412	210	
—	F/300	440		—	F/414	216	
—	F/302	500		—	F/416	350	
—	F/304	680		—	F/418	200	
—	F/306	716		—	F/420	230	
—	F/308	770		—	F/422	156	
—	F/310	1.050		—	F/424	216	
—	F/312	1.050		—	F/426	180	
—	F/314	1.050		—	F/428	240	
—	F/316	1.430		—	F/430	260	
—	F/318	1.430		—	F/432	360	
—	F/320	1.430		—	F/434	836	
—	F/322	1.540		—	F/436	870	

PAG. N°	ART. N°	PREZZO LISTINO	PREZZO NETTO	PAG. N°	ART. N°	PREZZO LISTINO	PREZZO NETTO
	G			132	G/144	8	
				132	G/145	12	
130	G/1	600 %		132	G/146	20	
130	G/11	380 %		132	G/147	32	
130	G/21	150 %		132	G/148	50	
130	G/22	150 %		132	G/161	4	
130	G/23	150 %		132	G/162	6	
130	G/24	150 %		132	G/163	8	
130	G/25	170 %		—	G/165	30	
130	G/26	500 %		132	G/171	8	
130	G/27	600 %		132	G/181	16	
130	G/28	600 %		132	G/191	78	
130	G/29	600 %		132	G/195	110	
—	G/39	250 %		133	G/201	36	
—	G/40	250 %		133	G/202	42	
130	G/41	240 %		133	G/205	20	
130	G/42	240 %		133	G/206	24	
130	G/43	300 %		133	G/207	28	
130	G/44	400 %		133	G/208	38	
130	G/61	400 %		133	G/209	42	
130	G/62	400 %		133	G/211	26	
130	G/63	400 %		133	G/213	24	
130	G/64	400 %		133	G/216	4	
130	G/65	400 %		133	G/217	36	
130	G/66	400 %		133	G/218	24	
130	G/67	400 %		134	G/231	4	
130	G/68	400 %		134	G/232	6	
131	G/101	400 %		134	G/236	4	
131	G/102	80 %		134	G/237	6	
131	G/103	150 %		134	G/261	26	
131	G/104	120 %		134	G/262	30	
131	G/105	150 %		134	G/263	54	
131	G/106	170 %		134	G/271	70	
131	G/107	20		—	G/272	125	
131	G/111	350 %		—	G/272-1	80	
131	G/116	220 %		—	G/273	78	
131	G/117	420 %		—	G/274	80	
131	G/118	600 %		—	G/274-1	66	
131	G/121	300 %		—	G/275	18	
132	G/131	40		—	G/276	10	
132	G/141	6		—	G/278	14	
132	G/142	6		—	G/279	14	
132	G/143	6		—	G/279-5	366	

PAG. N°	ART. N°	PREZZO LISTINO	PREZZO NETTO	PAG. N°	ART. N°	PREZZO LISTINO	PREZZO NETTO
—	G/280	310		137	G/401	48	
—	G/280-1	850		137	G/402	48	
—	G/280-2	1.076		137	G/403	36	
—	G/280-3	1.500		137	G/404	30	
—	G/280-5	826		137	G/405	44	
—	G/280-6	380		137	G/406	64	
134	G/281	70		137	G/411	36	
134	G/282	70		137	G/421	34	
134	G/283	80		137	G/422	58	
134	G/286	300		137	G/423	60	
—	G/287	24		137	G/424	88	
—	G/288	18		137	G/429	250	
135	G/301	2		137	G/430	570	
135	G/302	6		138	G/451	800 %	
135	G/303	10		138	G/452	600 %	
135	G/311	2		138	G/453	600 %	
135	G/312	8		138	G/454	600 %	
135	G/313	12		138	G/455	600 %	
135	G/314	14		138	G/456	800 %	
135	G/321	160		138	G/457	800 %	
135	G/322	170		138	G/458	600 %	
135	G/331	24		138	G/459	600 %	
135	G/341	24		138	G/460	600 %	
135	G/342	24		138	G/461	600 %	
135	G/343	24		138	G/462	600 %	
136	G/351	4		138	G/471	80	
136	G/352	6		138	G/472	80	
136	G/353	6		138	G/473	80	
136	G/354	8		138	G/474	80	
136	G/355	10		139	G/481	20	
136	G/356	14		139	G/482	56	
136	B/711	10		139	G/491	106	
136	B/712	10		139	G/492	86	
136	B/715	10		139	G/493	56	
136	B/716	10		139	G/494	60	
136	G/371	100		139	G/495	58	
136	G/375	80		139	G/496	54	
136	G/376	12		139	G/497	38	
136	G/377	12		139	G/498	36	
136	G/378	8		139	G/499	24	
136	G/379	8		139	G/500	26	
136	G/381	140		139	G/501	34	
136	G/382	140		139	G/502	94	

PAG. N°	ART. N°	PREZZO LISTINO	PREZZO NETTO	PAG. N°	ART. N°	PREZZO LISTINO	PREZZO NETTO
139	G/503	108		142	G/624	48	
139	G/504	64		142	G/625	80	
139	G/505	74		143	G/626	40	
139	G/506	66		143	G/628	48	
139	G/507	46		143	G/629	52	
139	G/508	46		608	G/630	70	
139	G/510	32		—	G/632	110	
139	G/511	36		—	G/634	62	
139	G/516	32		—	G/635	74	
139	G/517	32		143	G/636	48	
139	G/531	36		143	G/641	106	
139	G/541	110		143	G/646	184	
140	G/561	6		143	G/647	950	
140	G/562	6		144	G/651	70	
140	G/563	4		144	G/652	50	
140	G/571	450		144	G/653	50	
140	G/576	700		144	G/654	56	
140	G/577	330		144	G/655	56	
140	G/578	30		144	G/656	110	
140	G/581	70		144	G/657	60	
140	G/583	140		144	G/658	60	
140	G/586	94		144	G/659	110	
140	G/587	64		144	G/660	110	
140	G/588	42		144	G/661	60	
141	G/601	10		144	G/662	54	
141	G/602	68		145	G/671	74	
141	G/603	44		145	G/672	84	
141	G/604	28		145	G/673	140	
141	G/606	50		145	G/674	162	
141	G/607	20		145	G/675	162	
141	G/608	32		145	G/681	48	
141	G/609	42		145	G/682	170	
141	G/610	42		145	G/683	150	
141	G/611	52		145	G/684	420	
141	G/612	62		145	G/685	390	
142	G/614	62		145	G/687	320	
142	G/615	32		145	G/688	420	
142	G/617	20		145	G/689	260	
142	G/619	16		—	G/690	1.000	
142	G/620	14		—	G/690-1	880	
142	G/621	48		—	G/690-2	1.160	
142	G/622	48		—	G/690-3	660	
142	G/623	54		—	G/690-4	1.730	

PAG. N°	ART. N°	PREZZO LISTINO	PREZZO NETTO	PAG. N°	ART. N°	PREZZO LISTINO	PREZZO NETTO
146	G/691	80		149	G/799	18	
146	G/692	80		149	G/800	42	
146	G/693	44		150	G/811	60	
146	G/696	78		150	G/812	120	
146	G/697	84		150	G/813	80	
146	G/698	90		150	G/814	76	
146	G/699	84		150	G/815	90	
—	G/700	90		150	G/816	80	
—	G/700-1	90		150	G/819	200	
—	G/700-2	450		151	G/831	10	
—	G/705	120		151	G/832	12	
147	G/721	60		151	G/833	14	
147	G/722	90		151	G/834	22	
147	G/723	68		151	G/835	28	
147	G/724	68		151	G/836	40	
147	G/725	48		151	G/837	36	
147	G/726	48		151	G/838	150	
147	G/727	52		151	G/839	220	
147	G/728	150		151	G/851	18	
147	G/729	90		151	G/852	18	
148	G/741	90		152	G/853	26	
148	G/742	32		152	G/854	30	
148	G/743	56		152	G/856	42	
148	G/744	16		152	G/857	38	
148	G/745	42		152	G/858	52	
148	G/746	130		—	G/858-1	130	
148	G/747	40		152	G/859	240	
148	G/748	90		152	G/860	300	
148	G/749	130		152	G/861	130	
148	G/750	280		152	G/862	110	
149	G/781	28		152	G/863	110	
149	G/782	32		153	G/864	110	
149	G/783	32		153	G/865	110	
149	G/784	30		153	G/866	130	
149	G/785	30		153	G/867	130	
149	G/791	28		153	G/868	80	
149	G/792	28		153	G/869	110	
149	G/793	30		153	G/870	220	
149	G/794	30		153	G/871	220	
149	G/795	36		153	G/872	110	
149	G/796	18		153	G/873	60	
149	G/797	20		153	G/874	140	
149	G/798	16		153	G/875	240	

PAG. N°	ART. N°	PREZZO LISTINO	PREZZO NETTO	PAG. N°	ART. N°	PREZZO LISTINO	PREZZO NETTO
153	G/876	74		158	G/1017	830	
154	G/901	62		158	G/1018	800	
154	G/902	116		158	G/1019	830	
154	G/903	144		158	G/1020	1.050	
154	G/904	170		158	G/1021	1.080	
154	G/905	130		158	G/1022	1.050	
154	G/906	210		158	G/1023	700	
154	G/907	80		—	G/1026	630	
155	G/908	138		—	G/1030	430	
155	G/909	210		—	G/1031	450	
155	G/911	350		—	G/1032	480	
155	G/912	200		—	G/1033	510	
155	G/914	460		—	G/1034	530	
156	G/915	120		—	G/1035	510	
156	G/916	120		—	G/1036	660	
156	G/917	140		—	G/1037	660	
156	G/918	140		—	G/1038	660	
156	G/919	260		—	G/1039	750	
156	G/920	260		—	G/1040	800	
156	G/921	260		—	G/1041	850	
156	G/922	260		—	G/1042	850	
156	G/923	260		—	G/1043	1.050	
156	G/924	260		—	G/1044	1.050	
157	G/931	220		—	G/1045	1.200	
157	G/932	440		—	G/1046	1.300	
157	G/933	650		—	G/1047	1.350	
157	G/934	820		—	G/1048	1.350	
158	G/1001	420		—	G/1049	1.300	
158	G/1002	430		159	G/1051	1.300	
158	G/1003	420		159	G/1052	1.300	
158	G/1004	420		159	G/1053	1.400	
158	G/1005	450		159	G/1054	1.400	
158	G/1006	440		159	G/1055	1.300	
158	G/1007	420		159	G/1056	1.400	
158	G/1008	630		159	G/1057	1.400	
158	G/1009	630		159	G/1058	1.300	
158	G/1010	650		159	G/1059	1.400	
158	G/1011	800		159	G/1061	2.200	
158	G/1012	630		—	G/1062	1.500	
158	G/1013	620		—	G/1063	2.900	
158	G/1014	830		159	G/1071	950	
158	G/1015	750		159	G/1072	490	
158	G/1016	1.130		159	G/1081	2.200	

PAG. N°	ART. N°	PREZZO LISTINO	PREZZO NETTO	PAG. N°	ART. N°	PREZZO LISTINO	PREZZO NETTO
159	G/1082	1.700		—	G/1159	380	
159	G/1083	1.700		165	G/1161	300	
161	G/1092	250		165	G/1171	46	
161	G/1093	620		165	G/1201	416	
161	G/1094	1.350		165	G/1202	416	
161	G/1095	2.370		165	G/1203	774	
161	G/1096	870		165	G/1204	774	
161	G/1097	1.250		165	G/1205	50	
—	G/1098	620		165	G/1206	468	
162	G/1101	190		165	G/1207	468	
162	G/1101-N	180		165	G/1208	450	
162	G/1101-B	180		165	G/1209	450	
162	G/1102	224		165	G/1210	450	
162	G/1103	344		608	G/1210-1	750	
162	G/1104	364		166	G/1211	110	
162	G/1105	220		166	G/1212	136	
162	G/1106	240		166	G/1213	800	
162	G/1107	410		166	G/1214	800	
162	G/1108	500		166	G/1215	800	
162	G/1109	200		166	G/1215-1	800	
162	G/1110	210		166	G/1216	144	
162	G/1111	400		167	G/1221	300	
162	G/1112	450		167	G/1222	326	
163	G/1113	250		167	G/1223	350	
163	G/1114	310		167	G/1225	420	
163	G/1115	380		168	G/1261	820	
163	G/1116	400		168	G/1262	890	
163	G/1122	360		168	G/1263	740	
163	G/1123	300		168	G/1264	890	
163	G/1125	500		168	G/1265	820	
163	G/1126	800		168	G/1266	890	
163	G/1127	850		168	G/1267	890	
163	G/1128	950		168	G/1268	820	
164	G/1129	380		168	G/1269	890	
164	G/1130	1.120		168	G/1270	820	
164	G/1131	1.250		168	G/1271	740	
164	G/1141	860		168	G/1272	890	
164	G/1142	980		168	G/1273	890	
164	G/1151	390		168	G/1274	890	
164	G/1155	120		168	G/1275	820	
164	G/1156	120		168	G/1276	890	
164	G/1157	130		168	G/1277	890	
164	G/1158	130		168	G/1278	820	

PAG. N°	ART. N°	PREZZO LISTINO	PREZZO NETTO	PAG. N°	ART. N°	PREZZO LISTINO	PREZZO NETTO
168	G/1279	740		169	G/1348	740	
168	G/1280	890		169	G/1349	890	
168	G/1281	890		169	G/1350	740	
168	G/1282	820		169	G/1351	920	
168	G/1283	890		169	G/1352	740	
168	G/1301	580		169	G/1353	890	
168	G/1302	660		169	G/1354	890	
168	G/1303	730		169	G/1355	890	
168	G/1304	660		169	G/1356	890	
168	G/1305	660		169	G/1357	740	
168	G/1306	730		169	G/1358	890	
168	G/1307	880		169	G/1359	1.050	
168	G/1307-1	930		169	G/1360	1.190	
168	G/1308	670		169	G/1361	1.190	
168	G/1309	850		169	G/1362	860	
168	G/1310	730		169	G/1363	670	
168	G/1311	880		169	G/1363-1	740	
168	G/1312	960		169	G/1364	740	
168	G/1313	770		169	G/1365	890	
168	G/1314	1.100		169	G/1366	890	
168	G/1321	630		169	G/1367	670	
168	G/1322	660		169	G/1368	970	
168	G/1323	840		169	G/1369	1.100	
168	G/1324	780		169	G/1370	800	
168	G/1325	700		169	G/1371	970	
169	G/1331	630		169	G/1372	890	
169	G/1332	580		169	G/1373	780	
169	G/1333	580		169	G/1374	980	
169	G/1334	670		169	G/1375	1.100	
169	G/1335	770		169	G/1376	1.200	
169	G/1336	670		170	G/1401	740	
169	G/1337	740		170	G/1402	700	
169	G/1338	630		170	G/1403	700	
169	G/1339	590		170	G/1404	900	
169	G/1340	590		170	G/1405	700	
169	G/1341	770		170	G/1406	980	
169	G/1342	630		170	G/1407	950	
169	G/1343	670		170	G/1408	990	
169	G/1344	740		170	G/1409	850	
169	G/1344-1	890		170	G/1410	780	
169	G/1345	670		170	G/1411	750	
169	G/1346	740		170	G/1412	780	
169	G/1347	750		170	G/1413	950	

PAG. N°	ART. N°	PREZZO LISTINO	PREZZO NETTO	PAG. N°	ART. N°	PREZZO LISTINO	PREZZO NETTO
170	G/1414	1.000		176	G/1471-1	1.220	
607	G/1421	1.900		176	G/1471-2	1.220	
608	G/1422	750		176	G/1471-3	1.220	
170	G/1441	900		176	G/1471-4	1.220	
170	G/1442	900		176	G/1471-5	1.220	
170	G/1443	810		178	G/1471-6	1.300	
170	G/1444	810		178	G/1472	1.300	
170	G/1445	1.100		178	G/1472-1	1.300	
170	G/1446	1.100		178	G/1472-2	1.300	
170	G/1447	1.000		178	G/1472-3	1.300	
170	G/1448	900		178	G/1472-4	1.300	
170	G/1449	1.100		180	G/1472-6	1.500	
170	G/1450	600		180	G/1473	1.500	
170	G/1451	600		180	G/1474	1.500	
—	G/1461	650		180	G/1475	1.500	
170	G/1462	550		180	G/1476	1.500	
170	G/1463	750		180	G/1477	1.800	
170	G/1464	750		180	G/1478	1.800	
170	G/1465	750		180	G/1479	1.800	
170	G/1466	650		182	G/1480	650	
170	G/1467	800		183	G/1480-1	800	
172	G/1467-1	600		183	G/1480-2	600	
172	G/1467-2	100		183	G/1480-3	570	
172	G/1467-3	170		185	G/1481	1.300	
173	G/1468	1.020		185	G/1482	1.300	
173	G/1469	1.020		185	G/1483	1.300	
173	G/1470	1.020		185	G/1485	1.250	
173	G/1470-1	1.020		185	G/1486	1.250	
173	G/1470-2	1.020		185	G/1487	1.250	
173	G/1470-3	1.020		186	G/1488	1.700	
173	G/1470-4	1.020		186	G/1489	1.700	
173	G/1470-5	1.020		186	G/1490	1.700	
173	G/1470-6	1.020		186	G/1491	950	
174	G/1470-10	1.020		186	G/1492	950	
174	G/1470-11	1.020		186	G/1493	950	
174	G/1470-12	1.020		—	G/1495	1.130	
174	G/1470-13	1.020		187	G/1501	220	
174	G/1470-14	1.020		187	G/1502	220	
174	G/1470-15	1.020		187	G/1503	630	
174	G/1470-16	1.020		187	G/1504	490	
174	G/1470-17	1.020		188	G/1511	430	
174	G/1470-18	1.020		188	G/1512	430	
176	G/1471	1.220		188	G/1513	430	

PAG. N°	ART. N°	PREZZO LISTINO	PREZZO NETTO	PAG. N°	ART. N°	PREZZO LISTINO	PREZZO NETTO
188	G/1514	660		192	G/1579	730	
188	G/1515	590		192	G/1580	750	
607	G/1516	650		192	G/1581	750	
188	G/1521	650		192	G/1582	750	
188	G/1522	650		193	G/1601	2.380	
189	G/1531	430		193	G/1602	2.230	
189	G/1532	360		193	G/1603	2.900	
189	G/1533	400		193	G/1604	4.050	
189	G/1534	430		193	G/1605	3.240	
189	G/1535	430		193	G/1611	8.500	
189	G/1536	490		193	G/1612	8.130	
607	G/1537	400		193	G/1613	6.680	
—	G/1537-1	330		193	G/1621	350	
—	G/1538	170		193	G/1622	540	
190	G/1539	140		607	G/1623	1.100	
—	G/1539-1	116		194	G/1701	48	
190	G/1540	120		194	G/1702	48	
—	G/1540-1	106		194	G/1703	48	
—	G/1540-2	280		194	G/1704	48	
190	G/1541	98		194	G/1711	56	
190	G/1542	140		194	G/1712	56	
190	G/1543	310		194	G/1713	56	
190	G/1544	250		194	G/1714	56	
191	G/1551	820		194	G/1715	56	
191	G/1552	900		194	G/1716	116	
191	G/1553	840		194	G/1717	156	
191	G/1554	920		194	G/1721	64	
191	G/1555	920		194	G/1731	58	
191	G/1556	1.150		194	G/1736	100	
191	G/1557	880		194	G/1737	100	
191	G/1558	1.050		195	G/1741	280	
191	G/1559	880		195	G/1742	280	
191	G/1560	1.050		195	G/1744	280	
191	G/1561	1.050		195	G/1745	280	
191	G/1562	1.150		195	G/1746	280	
192	G/1571	460		195	G/1747	280	
192	G/1572	480		195	G/1748	320	
192	G/1573	730		195	G/1749	320	
192	G/1574	730		195	G/1750	320	
192	G/1575	730		195	G/1750-1	320	
192	G/1576	530		195	G/1750-2	320	
192	G/1577	730		195	G/1750-3	320	
192	G/1578	730		196	G/1761	130	

PAG. N°	ART. N°	PREZZO LISTINO	PREZZO NETTO	PAG. N°	ART. N°	PREZZO LISTINO	PREZZO NETTO
196	G/1762	140		200	G/1825-2	470	
196	G/1763	170		200	G/1826	820	
196	G/1771	30		200	G/1827	930	
196	G/1781	130		200	G/1828	470	
196	G/1782	140		200	G/1829	470	
196	G/1783	170		201	G/1830	210	
196	G/1786	130		201	G/1830-1	138	
196	G/1787	140		201	G/1831	560	
196	G/1788	170		201	G/1832	560	
196	G/1791	286		201	G/1834	560	
196	G/1792	286		201	G/1835	560	
196	G/1793	300		201	G/1836	560	
197	G/1801	58		201	G/1837	560	
197	G/1802	58		608	G/1841	420	
197	G/1803	74		608	G/1842	420	
197	G/1803-1	48		608	G/1843	420	
197	G/1804	86		608	G/1844	420	
197	G/1804-1	64		608	G/1845	420	
197	G/1805	110		608	G/1846	420	
197	G/1806	190		—	G/1850	420	
197	G/1806-1	130		—	G/1851	420	
197	G/1806-2	12		—	G/1852	420	
197	G/1806-3	12		—	G/1853	420	
198	G/1807	6		—	G/1854	420	
198	G/1808	20		—	G/1855	420	
198	G/1809	280		—	G/1900	140	
198	G/1810	280		—	G/1900-1	96	
198	G/1812	220		202	G/1901	78	
198	G/1813	220		202	G/1902	34	
198	G/1814	300		202	G/1903	34	
198	G/1815	300		202	G/1904	34	
199	G/1816	400		202	G/1905	76	
199	G/1817	400		202	G/1906	50	
199	G/1818	164		202	G/1907	50	
199	G/1819	140		202	G/1908	50	
199	G/1820	270		202	G/1909	50	
199	G/1821	320		202	G/2001	280	
199	G/1821-1	300		202	G/2002	280	
199	G/1822	290		202	G/2003	280	
200	G/1823	320		202	G/2005	80	
200	G/1824	110		202	G/2011	300	
200	G/1825	110		203	G/2016	230	
200	G/1825-1	470		203	G/2019	170	

PAG. Nº	ART. Nº	PREZZO LISTINO	PREZZO NETTO	PAG. Nº	ART. Nº	PREZZO LISTINO	PREZZO NETTO
—	G/2021	170		208	G/2140	16	
203	G/2026	320		208	G/2145	96	
203	G/2031	390		209	G/2201	54	
607	G/2033	250		209	G/2202	54	
203	G/2034	300		209	G/2203	38	
203	G/2035	300		209	G/2204	20	
203	G/2036	700		209	G/2206	36	
203	G/2041	2.700		209	G/2207	30	
203	G/2042	2.700		209	G/2208	34	
203	G/2043	2.700		209	G/2209	34	
204	G/2051	1.250		209	G/2221	60	
204	G/2052	270		—	G/2226	140	
204	G/2052-1	150		209	G/2231	72	
204	G/2053	160		210	G/2251	54	
204	G/2054	240		210	G/2251-1	62	
204	G/2055	350		210	G/2252	70	
205	G/2056	44		210	G/2252-1	76	
205	G/2057	10		210	G/2253	66	
205	G/2058	148		210	G/2261	44	
205	G/2059	42		210	G/2261-1	50	
205	G/2060	86		210	G/2262	44	
205	G/2061	420		210	G/2262-1	50	
206	G/2101	74		210	G/2263	44	
206	G/2101-1	74		210	G/2263-1	50	
206	G/2101-2	74		210	G/2271	32	
206	G/2102	58		211	G/2276	44	
206	G/2103	60		211	G/2277	18	
206	G/2105	64		211	G/2278	20	
206	G/2106	66		211	G/2281	14	
206	G/2107	60		211	G/2282	18	
206	G/2108	70		—	G/2283	22	
207	G/2111	98		211	G/2291	88	
207	G/2112	98		—	G/2291-1	100	
207	G/2113	98		211	G/2301	82	
207	G/2114	98		211	G/2305	50	
207	G/2115	180		211	G/2306	110	
207	G/2116	94		212	G/2307	74	
207	G/2118	280		212	G/2308	74	
208	G/2131	56		212	G/2311	88	
208	G/2132	62		212	G/2312	150	
208	G/2136	62		212	G/2313	54	
208	G/2137	62		212	G/2314	124	
208	G/2138	64		212	G/2315	146	

PAG. N°	ART. N°	PREZZO LISTINO	PREZZO NETTO	PAG. N°	ART. N°	PREZZO LISTINO	PREZZO NETTO
212	G/2316	146		217	G/2375-7	210	
212	G/2319	138		217	G/2375-8	250	
213	G/2321	60		217	G/2375-9	260	
213	G/2322	330		218	G/2375-11	520	
213	G/2323	300		218	G/2375-12	570	
—	G/2330	100		218	G/2375-13	600	
213	G/2335	98		218	G/2375-14	460	
213	G/2336	118		218	G/2375-15	600	
213	G/2341	326		218	G/2375-16	680	
213	G/2342	276		218	G/2375-17	790	
214	G/2345	200		219	G/2376	560	
214	G/2348	230		219	G/2377	670	
214	G/2349	250		219	G/2378	480	
215	G/2350	220		219	G/2379	570	
215	G/2351	220		219	G/2380	290	
215	G/2352	220		219	G/2381	290	
215	G/2353	220		219	G/2382	290	
215	G/2354	170		220	G/2383	290	
215	G/2355	170		220	G/2384	420	
215	G/2356	180		220	G/2395	240	
215	G/2357	290		220	G/2396	270	
215	G/2358	180		220	G/2401	650	
215	G/2359	180		220	G/2402	880	
215	G/2360	190		220	G/2411	730	
215	G/2361	220		220	G/2413	980	
216	G/2362	180		220	G/2415	1.100	
216	G/2363	190		220	G/2416	1.400	
216	G/2364	220		220	G/2421	290	
216	G/2365	220		220	G/2431	64	
216	G/2366	110		220	G/2432	74	
216	G/2367	180		—	G/2433	70	
216	G/2368	110		220	G/2436	150	
216	G/2369	220		220	G/2441	120	
216	G/2370	180		220	G/2442	124	
216	G/2371	180		220	G/2443	130	
216	G/2372	180		220	G/2445	400	
216	G/2373	180		220	G/2451	290	
217	G/2374	180		220	G/2452	150	
217	G/2375	180		222	G/2456	440	
217	G/2375-1	150		222	G/2457	440	
217	G/2375-2	270		222	G/2461	530	
217	G/2375-3	300		222	G/2462	570	
217	G/2375-6	136		222	G/2463	670	

PAG. N°	ART. N°	PREZZO LISTINO	PREZZO NETTO	PAG. N°	ART. N°	PREZZO LISTINO	PREZZO NETTO
222	G/2464	680		228	G/2523	110	
222	G/2465	780		228	G/2524	110	
222	G/2466	780		228	G/2525	206	
222	G/2467	830		228	G/2526	270	
222	G/2468	890		228	G/2527	184	
223	G/2469	830		229	G/2541	150	
223	G/2470	590		229	G/2542	150	
223	G/2471	690		229	G/2543	150	
223	G/2472	750		229	G/2544	150	
223	G/2473	1.150		229	G/2546	184	
223	G/2474	1.250		229	G/2548	216	
223	G/2481	230		230	G/2551	54	
223	G/2482	110		230	G/2555	160	
223	G/2483	96		230	G/2556	160	
223	G/2483-1	126		230	G/2557	126	
224	G/2484	420		230	G/2558	126	
224	G/2485	340		230	G/2559	140	
224	G/2486	350		230	G/2560-1	110	
224	G/2487	530		230	G/2560-2	110	
225	G/2491	680		231	G/2561	98	
225	G/2492	960		231	G/2562	54	
225	G/2498	620		231	G/2563	54	
225	G/2499	620		231	G/2564	54	
226	G/2501	60		231	G/2565	54	
226	G/2502	90		231	G/2568	54	
226	G/2503	90		231	G/2568-1	54	
226	G/2504	110		231	G/2568-2	54	
226	G/2505	150		231	G/2568-3	112	
226	G/2506	150		231	G/2568-6	48	
226	G/2507	150		232	G/2569	76	
226	G/2508	180		232	G/2570	80	
226	G/2509	190		232	G/2571	390	
226	G/2510	240		232	G/2576	52	
226	G/2511	260		232	G/2577	100	
226	G/2512	290		232	G/2577-1	116	
226	G/2513	290		232	G/2578	270	
226	G/2514	370		234	G/2601	74	
227	G/2516	34		234	G/2602	82	
227	G/2517	76		234	G/2603	90	
227	G/2518	54		234	G/2604	100	
227	G/2519	90		234	G/2608	140	
228	G/2521	16		234	G/2611	30	
228	G/2522	20		234	G/2612	30	

PAG. N°	ART. N°	PREZZO LISTINO	PREZZO NETTO	PAG. N°	ART. N°	PREZZO LISTINO	PREZZO NETTO
234	G/2613	30		239	G/2676	200	
234	G/2614	30		239	G/2676-1	250	
234	G/2615	38		240	G/2678	660	
234	G/2616	44		240	G/2679	290	
235	G/2617	58		240	G/2691	48	
235	G/2617-1	56		240	G/2692	44	
235	G/2618	56		240	G/2693	50	
235	G/2619	40		240	G/2694	42	
235	G/2620	96		240	G/2696	130	
235	G/2621	74		240	G/2701	74	
235	G/2622	72		241	G/2702	132	
235	G/2623	86		241	G/2703	40	
236	G/2624	92		241	G/2706	60	
236	G/2624-1	46		241	G/2707	78	
236	G/2625	92		241	G/2708	70	
236	G/2626	92		241	G/2709	46	
236	G/2641	44		242	G/2711	80	
236	G/2642	38		242	G/2712	70	
236	G/2643	48		242	G/2713	10	
237	G/2644	96		242	G/2714	60	
237	G/2644-1	56		242	G/2716	70	
237	G/2645	96		242	G/2717	18	
237	G/2646	96		242	G/2718	44	
237	G/2647	96		242	G/2719	12	
237	G/2648	114		242	G/2720	24	
237	G/2649	82		242	G/2721	150	
237	G/2650	82		243	G/2722	160	
237	G/2651	96		243	G/2723	176	
238	G/2652	40		243	G/2724	100	
238	G/2653	54		243	G/2725	340	
238	G/2653-1	54		243	G/2731	388	
238	G/2654	54		243	G/2732	388	
238	G/2654-1	54		243	G/2736	78	
238	G/2655	70		244	G/2741	140	
238	G/2655-1	70		244	G/2743	160	
238	G/2655-2	66		244	G/2751	1.600	
238	G/2658	50		244	G/2752	800	
239	G/2659	54		244	G/2752-1	900	
239	G/2662	80		244	G/2761	48	
239	G/2663	250		244	G/2762	54	
239	G/2671	20		244	G/2771	150	
239	G/2672	20		245	G/2776	420	
239	G/2675	200		245	G/2777	410	

PAG. N°	ART. N°	PREZZO LISTINO	PREZZO NETTO	PAG. N°	ART. N°	PREZZO LISTINO	PREZZO NETTO
245	G/2781	400		251	G/2860	46	
245	G/2782	400		251	G/2860-1	26	
245	G/2783	300		251	G/2860-2	26	
245	G/2784	250		251	G/2860-5	28	
245	G/2785	700		251	G/2860-6	30	
246	G/2791	360		252	G/2861	230	
246	G/2792	260		252	G/2862	240	
246	G/2792-1	194		252	G/2863	270	
246	G/2792-3	330		252	G/2864	240	
246	G/2793	230		252	G/2865	370	
246	G/2793-1	1.450		252	G/2866	320	
248	G/2793-5	1.000		252	G/2867	340	
248	G/2793-6	2.400		252	G/2867-5	170	
248	G/2794	146		252	G/2867-6	160	
248	G/2795	146		252	G/2873	70	
248	G/2795-1	136		253	G/2901	20	
—	G/2795-5	100		253	G/2902	20	
248	G/2795-6	100		253	G/2903	20	
248	G/2795-7	76		253	G/2904	20	
248	G/2796	100		253	G/2905	20	
248	G/2798	200		253	G/2906	20	
248	G/2799	90		253	G/2907	20	
249	G/2801	50		253	G/2908	20	
249	G/2802	50		253	G/2909	20	
249	G/2803	50		253	G/2910	20	
249	G/2804	50		253	G/2911	20	
249	G/2805	50		253	G/2912	20	
249	G/2811	100		253	G/2913	20	
249	G/2812	114		253	G/2914	20	
249	G/2813	124		253	G/2915	20	
249	G/2814	138		253	G/2916	20	
250	G/2851	52		253	G/2917	20	
250	G/2852	54		253	G/2918	20	
250	G/2853	58		253	G/2920	20	
250	G/2855	20		253	G/2921	20	
250	G/2856	58		253	G/2922	20	
250	G/2857	62		253	G/2923	20	
250	G/2858	24		253	G/2924	20	
250	G/2858-1	54		253	G/2925	20	
250	G/2858-2	60		253	G/2926	20	
250	G/2858-5	20		253	G/2927	20	
250	G/2858-6	20		253	G/2928	20	
251	G/2859	46		253	G/2929	20	

PAG. N°	ART. N°	PREZZO LISTINO	PREZZO NETTO	PAG. N°	ART. N°	PREZZO LISTINO	PREZZO NETTO
253	G/2930	20		257	G/3022-2	550	
254	G/2931	24		257	G/3023	110	
254	G/2932	24		257	G/3031	200	
254	G/2933	24		257	G/3032	400	
254	G/2934	24		257	G/3036	106	
254	G/2936	48		257	G/3037	138	
254	G/2937	48		257	G/3038	190	
254	G/2938	48		257	G/3039	250	
254	G/2939	48					
254	G/2941	480			H		
254	G/2942	1.400					
254	G/2943	1.500					
—	G/2944	2.000		258	H/2	1.350	
—	G/2945	900		258	H/3	1.400	
—	G/2946	2.200		258	H/4	1.400	
—	G/2947	1.650		258	H/11	650	
—	G/2948	880		258	H/12	650	
—	G/2949	350		258	H/13	650	
255	G/2951	22		258	H/14	650	
255	G/2952	38		258	H/15	650	
255	G/2953	52		258	H/16	650	
255	G/2954	14		258	H/17	650	
255	G/2955	26		258	H/18	650	
255	G/2956	4		258	H/19	750	
256	G/2957	26		258	H/20	750	
255	G/3001	200		258	H/21	750	
256	G/3002	150		258	H/22	750	
256	G/3003	1.250		258	H/31	630	
256	G/3004	1.700		258	H/32	630	
256	G/3005	2.200		258	H/33	630	
256	G/3006	3.120		258	H/35	630	
256	G/3007	3.750		258	H/36	630	
256	G/3008	680		258	H/37	630	
256	G/3009	2.000		258	H/38	630	
256	G/3010	260		258	H/39	630	
257	G/3011	140		258	H/40	630	
257	G/3011-1	210		258	H/41	630	
257	G/3011-2	270		259	H/42	750	
257	G/3012	120		259	H/43	750	
257	G/3013	70		259	H/44	750	
257	G/3021	130		259	H/45	750	
257	G/3022	290		259	H/46	750	
257	G/3022-1	390		259	H/47	750	

PAG. N°	ART. N°	PREZZO LISTINO	PREZZO NETTO	PAG. N°	ART. N°	PREZZO LISTINO	PREZZO NETTO
259	H/48	750		260	H/86	580	
259	H/49	750		260	H/87	580	
259	H/50	750		260	H/88	580	
259	H/50-1	950		260	H/89	580	
259	H/50-2	950		261	H/91	550	
259	H/50-3	950		261	H/92	550	
259	H/50-4	950		261	H/93	550	
259	H/50-5	950		261	H/94	550	
259	H/50-6	950		—	H/94-1	550	
259	H/50-11	1.500		—	H/95	1.000	
259	H/50-12	1.500		—	H/96	1.000	
259	H/50-16	1.750		—	H/96-1	1.000	
259	H/50-17	1.750		—	H/97	900	
259	H/50-18	1.750		—	H/97-1	1.250	
260	H/51	1.450		—	H/97-2	1.000	
260	H/52	1.450		—	H/97-3	900	
260	H/53	1.450		—	H/97-4	650	
—	H/54	630		261	H/98	1.800	
—	H/55	630		261	H/99	600	
—	H/56	630		—	H/100	600	
—	H/57	630		—	H/100-1	1.000	
—	H/58	630		—	H/100-2	1.000	
—	H/59	630		—	H/100-3	700	
260	H/61	630		—	H/100-4	900	
260	H/62	630		—	H/100-5	800	
260	H/63	630		—	H/100-6	650	
260	H/64	630		—	H/100-7	400	
260	H/65	630		262	H/101	2.420	
260	H/66	630		262	H/102	2.860	
260	H/67	630		262	H/103	3.740	
260	H/68	630		262	H/104	3.700	
260	H/69	630		262	H/105	4.840	
260	H/70	630		262	H/106	6.500	
260	H/71	630		262	H/107	6.500	
260	H/72	630		262	H/108	13.200	
260	H/73	630		—	H/131	900	
260	H/74	630		263	H/132	1.480	
260	H/75	630		263	H/133	1.280	
260	H/81	580		263	H/134	1.280	
260	H/82	580		—	H/134-1	850	
260	H/83	580		263	H/135	1.700	
260	H/84	580		263	H/136	3.400	
260	H/85	580		—	H/136-1	9.000	

PAG. Nº	ART. Nº	PREZZO LISTINO	PREZZO NETTO	PAG. Nº	ART. Nº	PREZZO LISTINO	PREZZO NETTO
—	H/136-2	2.000		266	H/205	1.400	
263	H/137	790		267	H/211	7.000	
263	H/138	900		267	H/212	15.000	
264	H/151	3.600		267	H/213	17.000	
264	H/152	3.600		267	H/214	14.000	
264	H/153	3.600		267	H/215	14.000	
264	H/154	3.600		267	H/221	10.500	
264	H/161	2.500		267	H/222	10.500	
264	H/171	3.200		267	H/223	10.500	
264	H/172	3.200		267	H/224	20.000	
264	H/173	3.200		267	H/225	20.000	
265	H/174	3.200		267	H/226	20.000	
265	H/175	2.900		267	H/227	22.000	
265	H/176	2.900		267	H/228	22.000	
265	H/181	2.700		267	H/229	22.000	
265	H/182	2.700		267	H/230	14.500	
265	H/183	2.700		267	H/231	14.500	
—	H/184	1.800		268	H/240	8.800	
—	H/184-2	2.300		—	H/240-1	8.800	
—	H/184-3	2.300		—	H/240-2	8.800	
—	H/184-4	2.800		—	H/240-3	8.800	
265	H/185	1.300		268	H/241	7.400	
265	H/186	1.600		268	H/242	2.000	
265	H/187	3.800		268	H/243	8.600	
—	H/187-1	2.000		—	H/245	5.000	
—	H/187-2	1.900		269	H/251	—	
—	H/188	1.600		269	H/253	—	
—	H/189	3.450		270	H/254	—	
—	H/190	1.150		270	H/255	—	
—	H/190-1	1.150		271	H/271	12.000	
—	H/190-2	1.150		271	H/281	3.000	
—	H/190-3	1.000		271	H/282	3.800	
—	H/190-4	1.950		271	H/283	4.400	
—	H/190-5	1.000		271	H/284	4.000	
—	H/190-6	2.200		271	H/285	4.400	
—	H/190-7	900		271	H/290	730	
—	H/190-8	900		271	H/291	830	
—	H/190-9	1.250		271	H/295	730	
266	H/191	1.400		271	H/296	870	
266	H/192	1.400		—	H/300	8.500	
266	H/193	1.000		272	H/350	—	
266	H/201	1.500		272	H/351	—	
266	H/203	1.100		272	H/352	—	

PAG. N°	ART. N°	PREZZO LISTINO	PREZZO NETTO	PAG. N°	ART. N°	PREZZO LISTINO	PREZZO NETTO
272	H/353	—		279	I/11	4.600	
272	H/354	—		279	I/12	4.800	
272	H/355	—		279	I/13	4.900	
272	H/356	—		279	I/14	4.800	
272	H/357	—		280	I/21	4.300	
272	H/358	—		280	I/22	4.300	
272	H/359	—		280	I/23	4.300	
272	H/360	—		280	I/24	4.300	
272	H/361	—		280	I/25	5.800	
272	H/381	4.600		280	I/26	5.800	
273	H/401	1.200		280	I/27	5.800	
273	H/402	1.200		280	I/28	5.800	
273	H/406	1.300		280	I/29	6.800	
273	H/407	1.300		280	I/30	6.800	
273	H/411	2.350		280	I/36	4.400	
274	H/455	—		280	I/37	4.400	
274	H/450	—		282	I/41	4.400	
274	H/445	—		282	I/42	4.400	
274	H/446	—		282	I/43	5.800	
275	H/453	—		282	I/44	5.800	
275	H/451	—		282	I/61	6.400	
—	H/453-1	—		282	I/62	560	
—	H/453-2	—		283	I/101	650	
275	H/453-5	—		283	I/102	950	
275	H/457	—		283	I/103	1.150	
276	H/456	—		283	I/104	750	
276	H/454	—		283	I/111	450	
276	H/452	—		283	I/112	750	
276	H/461	—		283	I/113	530	
277	H/471	—		283	I/122	1.950	
—	H/475	27.350		283	I/126	2.900	
—	H/476	31.900		283	G/271	70	
—	H/477	45.600		283	G/281	70	
				283	G/282	70	
				283	G/283	80	
				283	G/286	300	
				284	I/301	—	
279	I/1	3.600		—	I/301-1	—	
279	I/2	3.800		284	I/302	—	
279	I/3	3.900		284	I/303	—	
279	I/4	4.600		284	I/304	—	
279	I/5	4.800		—	I/305	—	
279	I/6	4.900		284	I/305-1	—	

PAG. N°	ART. N°	PREZZO LISTINO	PREZZO NETTO	PAG. N°	ART. N°	PREZZO LISTINO	PREZZO NETTO
284	1/306	—		288	1/431	—	
284	1/307	—		288	1/432	—	
—	1/310	—		288	1/436	—	
285	1/311	—		289	1/441	—	
285	1/312	—		289	1/442	—	
—	1/313	—		289	1/443	—	
—	1/314	—		289	1/444	—	
—	1/316	—		289	1/445	—	
—	1/317	—		289	1/446	—	
285	1/321	—		289	1/447	—	
285	1/322	—		289	1/448	—	
285	1/323	—		289	1/449	—	
285	1/324	—		289	1/450	—	
285	1/325	—		—	1/450-1	—	
285	1/325-1	—		—	1/450-2	—	
—	1/325-2	—		290	1/451	—	
285	1/326	—		290	1/452	—	
285	1/331	—		290	1/452-1	—	
285	1/332	—		290	1/453	—	
285	1/333	—		290	1/454	—	
286	1/401	—		290	1/461	—	
286	1/402	—		290	1/462	—	
286	1/402-1	—		290	1/463	—	
286	1/403	—		290	1/471	—	
—	1/403-1	—		290	1/472	—	
286	1/404	—		290	1/473	—	
286	1/404-1	—		290	1/474	—	
—	1/404-2	—		—	1/517	—	
286	1/405	—		—	1/600	2.100	
286	1/406	—		—	1/601	2.200	
286	1/407	—		—	1/605	2.650	
287	1/411	—		—	1/606	2.650	
287	1/412	—		—	1/700	—	
—	1/413	—		—	1/701	—	
287	1/416	—		—	1/702	—	
287	1/421	—		—	1/703	—	
—	1/421-1	—		—	1/704	—	
287	1/422	—		—	1/705	—	
287	1/422-1	—		—	1/706	—	
287	1/422-2	—		—	1/707	—	
287	1/422-3	—		—	1/708	—	
288	1/423	—		—	1/709	—	
288	1/426	—		—		—	

PAG. N°	ART. N°	PREZZO LISTINO	PREZZO NETTO	PAG. N°	ART. N°	PREZZO LISTINO	PREZZO NETTO
	L			296	L/212	500	
				296	L/213	260	
292	L/1	750		296	L/214	230	
292	L/2	2.000		296	L/215	710	
292	L/6	750		297	L/216	600	
292	L/7	2.000		297	L/217	600	
292	L/11	850		297	L/218	600	
292	L/12	2.000		297	L/219	600	
292	L/16	2.300		297	L/221	600	
292	L/17	2.300		297	L/222	600	
292	L/21	1.500		297	L/223	600	
292	L/22	2.500		297	L/224	600	
292	L/26	2.000		297	L/231	1.300	
292	L/27	2.300		297	L/232	1.300	
293	L/51	330		297	L/233	1.300	
293	L/52	360		297	L/234	1.300	
293	L/53	370		297	L/235	1.300	
293	L/56	450		297	L/236	1.300	
293	L/57	700		297	L/237	1.500	
293	L/61	200		297	L/238	1.750	
293	L/62	370		297	L/239	11.100	
293	L/71	100		297	L/241	740	
293	L/81	600		297	L/242	740	
294	L/91	2.900		297	L/243	500	
294	L/101	2.300		297	L/244	360	
294	L/102	1.600		297	L/251	1.600	
294	L/103	2.600		298	L/252	2.800	
294	L/104	850		298	L/253	3.000	
295	L/121	220		298	L/254	2.500	
295	L/122	276		298	L/255	3.100	
295	L/123	496		298	L/256	2.900	
295	L/124	496		298	L/257	3.100	
296	L/201	600		298	L/258	1.950	
296	L/202	820		298	L/259	2.400	
296	L/203	820		299	L/260	1.600	
296	L/204	540		299	L/261	1.900	
296	L/205	330		299	L/262	1.950	
296	L/206	450		299	L/263	2.400	
296	L/207	280		299	L/264	3.500	
296	L/208	260		299	L/271	6.800	
296	L/209	200		300	L/281	1.850	
296	L/210	200		300	L/282	2.000	
296	L/211	200		300	L/283	1.800	

PAG. N°	ART. N°	PREZZO LISTINO	PREZZO NETTO	PAG. N°	ART. N°	PREZZO LISTINO	PREZZO NETTO
300	L/284	2.050		309	L/396-2	2.800	
300	L/285	1.950		309	L/396-3	2.900	
300	L/286	2.250		309	L/396-4	3.000	
300	L/287	1.450		309	L/396-5	3.000	
300	L/288	1.750		309	L/396-6	250	
301	L/291	9.800		309	L/397	3.100	
301	L/292	13.000		309	L/397-1	3.600	
301	L/294	16.800		309	L/397-2	3.750	
301	L/295	1.200		309	L/397-3	4.300	
302	L/301	2.850		309	L/397-4	6.400	
302	L/301-1	1.500		309	L/397-5	6.600	
302	L/302	5.500		309	L/397-6	7.900	
303	L/303	10.000		309	L/398	5.900	
303	L/304	15.700		310	L/401	4.300	
304	L/305	1.450		310	L/402	4.300	
304	L/306	1.600		310	L/403	4.300	
304	L/307	1.200		310	L/404	4.300	
304	L/308	980		310	L/405	5.700	
305	L/309	35.500		310	L/406	4.300	
306	L/310	24.900		310	L/407	4.300	
307	L/311	15.700		310	L/407-1	4.300	
—	L/312	27.250		310	L/408	5.700	
307	L/337	950		—	L/408-1	5.800	
—	L/338	950		310	L/409	150	
—	L/339	1.150		310	L/421	150	
—	L/340	1.200		310	L/422	150	
—	L/341	1.400		310	L/423	650	
308	L/351	50		310	L/424	250	
308	L/352	430		311	L/451	1.100	
308	L/353	200		311	L/452	1.100	
308	L/354	110		311	L/453	1.100	
308	L/356	170		311	L/454	2.600	
308	L/357	200		311	L/461	280	
308	L/358	140		311	L/462	660	
308	L/359	140		311	L/466	340	
308	L/360	800		311	L/467	430	
308	L/361	800		311	L/471	3.000	
308	L/362	800		311	L/472	3.750	
309	L/391	5.800		311	L/473	3.370	
—	L/392	8.000		311	L/474	4.120	
—	L/393	8.500		311	L/475	3.370	
309	L/396	2.400		311	L/476	4.120	
309	L/396-1	2.700		311	L/477	3.500	

PAG. N°	ART. N°	PREZZO LISTINO	PREZZO NETTO	PAG. N°	ART. N°	PREZZO LISTINO	PREZZO NETTO
311	L/478	4.500		315	L/556	900	
312	L/481	1.120		315	L/557	900	
312	L/482	1.630		315	L/558	900	
312	L/483	1.250		315	L/559	900	
312	L/484	1.870		315	L/560	1.300	
312	L/485	1.250		315	L/561	1.300	
312	L/486	1.870		315	L/562	2.600	
312	L/487	1.250		316	L/566	3.780	
312	L/488	1.870		316	L/567	3.780	
312	L/491	250		316	L/571	3.400	
312	L/492	400		316	L/572	3.400	
312	L/493	450		316	L/573	3.400	
312	L/501	3.850		316	L/574	3.700	
312	L/502	3.850		316	L/575	3.700	
312	L/503	1.300		—	L/575-1	2.600	
606	L/506	5.100		—	L/575-2	2.600	
606	L/507	6.400		—	L/575-3	2.850	
313	L/511	8.300		—	L/575-4	2.850	
313	L/512	8.650		—	L/575-5	3.300	
—	L/513	640		—	L/575-6	3.300	
313	L/518	220		—	L/575-7	3.600	
313	L/519	610		—	L/575-8	3.600	
—	L/520	7.500		—	L/579	1.600	
—	L/521	5.450		317	L/580	2.100	
—	L/522-1	7.000		317	L/581	1.600	
—	L/523-1	2.500		317	L/582	1.700	
—	L/524-1	530		—	L/585	800	
313	L/527	5.650		—	L/586	850	
313	L/528	5.650		—	L/587	1.050	
313	L/529	5.650		—	L/588	1.450	
313	L/530	2.550		—	L/589	450	
313	L/530-1	400		—	L/589-1	450	
314	L/531.	7.600		—	L/589-2	600	
314	L/532	8.850		—	L/589-3	600	
314	L/533	17.000		—	L/589-4	800	
314	L/534	21.500		—	L/589-5	800	
606	L/549	2.550		317	L/590	200	
606	L/550	3.200		317	L/591	350	
315	L/551	900		317	L/592	400	
315	L/552	900		317	L/592-1	200	
—	L/553-1	900		317	L/593	350	
—	L/554-1	900		317	L/594	400	
315	L/555	900		317	L/595	380	

PAG. N°	ART. N°	PREZZO LISTINO	PREZZO NETTO	PAG. N°	ART. N°	PREZZO LISTINO	PREZZO NETTO
318	L/601	1.650		321	L/827	450	
318	L/602	1.570		321	L/828	450	
318	L/602-1	890		321	L/829	1.150	
318	L/602-2	890		321	L/830	1.150	
318	L/603	1.580		322	L/831	200	
318	L/604	1.760		322	L/832	1.400	
318	L/605	2.000		—	L/835	400	
318	L/606	1.600		—	L/836	200	
318	L/607	1.760		323	L/901	3.800	
318	L/608	2.000		323	L/902	4.250	
319	L/611	180		323	L/903	5.250	
319	L/615	300		323	L/904	4.250	
319	L/621	136		323	L/905	4.000	
319	L/622	144					
319	L/701	180			M		
319	L/702	130					
319	L/703	200					
—	L/735	5.400		324	M/11	8.800	
320	L/801	450		325	M/16	850	
320	L/803	1.150		325	M/17	680	
320	L/804	450		325	M/18	1.500	
320	L/805	1.150		325	M/19	1.750	
320	L/806	450		325	M/21	1.700	
320	L/807	1.500		325	M/22	1.800	
320	L/808	1.050		326	M/72	13.500	
320	L/809	1.250		327	M/91	1.000	
320	L/810	1.050		327	M/92	370	
320	L/812	1.150		327	M/93	1.100	
320	L/813	5.250		327	M/94	450	
—	L/813-1	2.250		328	M/123	220	
320	L/814	1.150		328	M/124	220	
321	L/815	1.050		328	M/125	220	
321	L/816	1.050		328	M/126	70	
321	L/817	250		328	M/127	50	
321	L/818	250		328	M/128	76	
321	L/819	250		328	M/129	300	
321	L/820	250		328	M/136	800	
321	L/821	1.150		328	M/137	1.000	
321	L/822	1.150		328	M/138	400	
321	L/823	450		328	M/139	450	
321	L/824	1.400		329	M/146	300	
321	L/825	1.400		329	M/147	390	
321	L/826	1.150		329	M/149	260	
				329	M/156	100	

PAG. N°	ART. N°	PREZZO LISTINO	PREZZO NETTO	PAG. N°	ART. N°	PREZZO LISTINO	PREZZO NETTO
330	M/160	4.400		—	M/380-8	450	
330	M/162	4.400		—	M/381	4.600	
331	M/176	5.200		—	M/382	880	
—	M/176-1	5.300		—	M/383	1.780	
331	M/181	94		—	M/384	1.700	
—	M/187	230		—	M/386	19.500	
—	M/188	60		—	M/386-1	11.900	
331	M/191	180		—	M/387	8.500	
331	M/211	1.350		—	M/387-1	5.700	
332	M/221	700		—	M/388	9.500	
332	M/222	300		—	M/388-1	8.000	
332	M/261	400		—	M/389	3.500	
332	M/262	400		—	M/390	11.900	
332	M/271	300		—	M/391	11.900	
332	M/272	300		—	M/392	4.600	
333	M/281	300		—	M/400	380	
333	M/291	1.100		—	M/402	380	
333	M/296	400		335	M/521	5.500	
333	M/301	1.300		335	M/522	4.800	
—	M/311	6.500		335	M/531	1.600	
—	M/321	4.800		335	M/532	1.900	
—	M/322	1.800		335	M/533	1.850	
—	M/323	1.850		336	M/551	17.500	
—	M/331	7.800		336	M/552	12.900	
—	M/332	5.600		337	M/571	9.800	
—	M/333	4.900		337	M/572	10.800	
—	M/334	7.000		338	M/582	4.800	
—	M/336	9.000		339	M/593-1	600	
—	M/340	1.400		339	M/593-2	300	
—	M/341	1.800		339	M/593-3	200	
—	M/345	1.150		339	M/593-5	750	
—	M/346	180		339	M/593-6	330	
—	M/347	400		339	M/593-7	330	
—	M/351	700		—	M/593-8	400	
—	M/360	25.000		341	M/598	1.700	
—	M/380	5.900		—	M/598-1	1.600	
—	M/380-1	600		—	M/598-2	1.600	
—	M/380-2	280		—	M/598-3	1.600	
—	M/380-3	550		—	M/598-4	1.600	
—	M/380-4	300		—	M/598-5	1.600	
—	M/380-5	800		—	M/598-6	1.600	
—	M/380-6	50		—	M/598-7	1.600	
—	M/380-7	950		341	M/599	1.750	

PAG. N°	ART. N°	PREZZO LISTINO	PREZZO NETTO	PAG. N°	ART. N°	PREZZO LISTINO	PREZZO NETTO
341	M/599-1	1.750		—	M/661-2	4.000	
341	M/599-2	1.750		353	M/662	3.600	
341	M/599-3	1.750		353	M/663	4.600	
—	M/599-4	1.800		353	M/664	9.700	
343	M/600	3.600		354	M/665	6.300	
343	M/600-2	3.600		354	M/665-1	4.500	
343	M/601	3.500		355	M/681	3.300	
343	M/601-1	3.500		355	M/701	1.000	
344	M/602	3.500		—	M/706	3.900	
344	M/602-2	3.500		355	M/711	2.100	
344	M/603	3.500		355	M/712	3.600	
345	M/603-3	3.500		356	M/731	3.600	
345	M/604	3.500		356	M/732	4.500	
346	M/604-4	3.500		356	M/733	4.200	
346	M/605	3.500		356	M/741	700	
—	M/605-3	3.500		356	M/742	850	
347	M/605-5	3.500		357	M/771	15.500	
—	M/605-6	3.500					
—	M/605-8	3.500			N		
—	M/606-1	3.620					
—	M/607-1	3.620		358	N/1	66	
—	M/608-1	3.620		358	N/2	90	
348	M/609	4.500		358	N/3	106	
348	M/610	4.500		358	N/4	1.380	
348	M/611	4.500		358	N/5	1.650	
348	M/612	4.500		359	N/21	220	
348	M/613	4.500		359	N/21-1	220	
349	M/633	7.900		359	N/21-2	220	
349	M/634	7.900		359	N/22	220	
350	M/635-1	4.150		359	N/23	180	
350	M/635-2	4.150		359	N/24	390	
350	M/641	5.700		359	N/25	220	
350	M/641-1	4.150		360	N/61	5.250	
350	M/641-2	4.150		360	N/91	3.500	
351	M/642-1	4.150		360	N/101	2.200	
351	M/642-2	4.150		—	N/110	4.840	
351	M/643	9.750		361	N/121	1.000	
—	M/649	6.100		—	N/121-1	850	
—	M/651	4.550		—	N/130	380	
—	M/652	6.900		361	N/131	2.550	
—	M/653	8.800		361	N/131-1	4.300	
—	M/656	4.750		361	N/132	3.900	
352	M/661	7.700		362	N/141	2.600	

PAG. Nº	ART. Nº	PREZZO LISTINO	PREZZO NETTO	PAG. Nº	ART. Nº	PREZZO LISTINO	PREZZO NETTO
—	N/142	2.200		365	N/363	3.800	
362	N/145	2.400		365	N/371	5.600	
362	N/151	2.380		365	N/372	4.600	
363	N/161	2.500		365	N/373	3.800	
363	N/162	2.350		365	N/381	2.600	
363	N/164	2.350		365	N/382	2.300	
—	N/165	1.870		365	N/383	2.100	
—	N/166	2.500		365	N/391	3.000	
—	N/167	1.750		365	N/392	2.600	
—	N/168	1.200		365	N/393	2.300	
363	N/171	3.700		365	N/394	2.100	
363	N/172	400		365	N/401	2.600	
364	N/251	3.200		365	N/402	2.300	
364	N/252	3.700		365	N/403	2.100	
364	N/253	4.400		365	N/411	3.000	
364	N/261	3.200		365	N/412	2.600	
364	N/262	3.700		365	N/413	2.300	
364	N/263	4.400		365	N/414	2.100	
364	N/271	3.200		365	N/421	2.600	
364	N/272	3.700		365	N/422	2.300	
364	N/273	4.400		365	N/423	2.100	
364	N/281	2.000		365	N/431	4.200	
364	N/282	2.200		365	N/432	3.500	
364	N/283	2.500		365	N/441	1.300	
364	N/291	2.000		366	N/451	2.800	
364	N/292	2.200		366	N/452	3.200	
364	N/293	2.500		366	N/453	3.600	
364	N/301	2.000		366	N/461	2.800	
364	N/302	2.200		366	N/462	2.800	
364	N/303	2.500		366	N/463	2.800	
364	N/311	2.000		366	N/464	2.800	
364	N/312	2.200		—	N/465	1.600	
364	N/313	2.500		—	N/466	1.600	
364	N/321	2.000		—	N/467	2.000	
364	N/322	2.200		—	N/468	3.500	
364	N/323	2.500		—	N/468-1	3.000	
364	N/331	3.200		—	N/469	17.700	
364	N/332	3.700		—	N/470	3.700	
365	N/351	5.600		367	N/470-1	2.750	
365	N/352	4.600		—	N/470-2	2.950	
365	N/353	3.800		367	N/470-3	3.450	
365	N/361	5.600		367	N/470-4	3.950	
365	N/362	4.600		367	N/471-2	2.700	

PAG. N°	ART. N°	PREZZO LISTINO	PREZZO NETTO	PAG. N°	ART. N°	PREZZO LISTINO	PREZZO NETTO
367	N/471-3	3.200		368	N/485-5	2.600	
367	N/471-4	3.700		368	N/485-6	3.100	
367	N/472-3	2.000		368	N/486-3	2.000	
367	N/472-4	2.200		368	N/486-4	2.200	
367	N/472-5	2.600		368	N/486-5	2.600	
367	N/472-6	3.100		368	N/486-6	3.100	
367	N/473-3	2.000		368	N/487-3	2.000	
367	N/473-4	2.200		368	N/487-4	2.200	
367	N/473-5	2.600		368	N/487-5	2.600	
367	N/473-6	3.100		368	N/487-6	3.100	
367	N/474-3	2.000		368	N/488	1.350	
367	N/474-4	2.200		368	N/489	1.850	
367	N/474-5	2.600		368	N/490	2.350	
367	N/474-6	3.100		369	N/501	19.900	
367	N/475-3	2.000		369	N/502	19.900	
367	N/475-4	2.200		369	N/503	19.900	
367	N/475-5	2.600		369	N/504	19.900	
367	N/475-6	3.100		369	N/505	19.900	
367	N/476-3	2.000		369	N/506	19.900	
367	N/476-4	2.200		369	N/507	19.900	
367	N/476-5	2.600		369	N/508	19.900	
367	N/476-6	3.100		369	N/511	38.500	
367	N/477	1.350		369	N/512	38.500	
367	N/478	1.850		369	N/513	38.500	
367	N/479	2.350		369	N/514	38.500	
—	N/481	1.360		369	N/515	38.500	
—	N/481-1	1.360		369	N/516	38.500	
368	N/481-2	2.950		369	N/517	38.500	
368	N/481-3	3.400		369	N/518	38.500	
368	N/481-4	3.900		370	N/601	480	
368	N/482-2	2.700		370	N/602	570	
368	N/482-3	3.200		370	N/603	480	
368	N/482-4	3.700		370	N/604	750	
368	N/483-3	2.000		370	N/605	64	
368	N/483-4	2.200		—	N/605-1	580	
368	N/483-5	2.600		370	N/606	750	
368	N/483-6	3.100		370	N/606-1	870	
368	N/484-3	2.000		—	N/606-2	1.000	
368	N/484-4	2.200		370	N/607	940	
368	N/484-5	2.600		370	N/607-1	1.100	
368	N/484-6	3.100		—	N/607-2	1.250	
368	N/485-3	2.000		370	N/608	1.120	
368	N/485-4	2.200		370	N/608-1	1.300	

PAG. N°	ART. N°	PREZZO LISTINO	PREZZO NETTO	PAG. N°	ART. N°	PREZZO LISTINO	PREZZO NETTO
—	N/608-2	1.500		375	N/804	60	
370	N/609	100		375	N/812	250	
370	N/610	750		375	N/821	390	
370	N/610-1	950		376	N/834	98	
370	N/611	170		376	N/841	18	
—	N/612	420		376	N/842	34	
—	N/615	720		377	N/851	28	
—	N/616	850		377	N/852	12	
—	N/620	260		377	N/856	12	
370	N/631	198		—	N/857	8	
371	N/641	160		377	N/858	24	
371	N/642	200		377	N/871	58	
—	N/652	176		378	N/891	4	
371	N/656	40		378	N/892	2	
—	N/656-1	56		378	N/893	8	
371	N/661	174		378	N/894	2	
371	N/662	106		378	N/901	4	
371	N/663	156		378	N/911	14	
—	N/669	200		378	N/912	14	
—	N/670	220		378	N/913	18	
371	N/671	870		378	N/921	8	
371	N/672	2.250		378	N/926	8	
371	N/673	1.600		—	N/930	80	
372	N/676	2.150		379	N/931	124	
372	N/677	1.800		379	N/932	74	
372	N/678	500		379	N/933	110	
372	N/679	40		379	N/936	50	
372	N/681	100		379	N/941	64	
—	N/682	90		379	N/946	44	
372	N/701	290		379	N/951	78	
372	N/702	290		380	N/961	4	
372	N/713	98		380	N/962	12	
372	N/730	100		380	N/963	8	
373	N/731	650		380	N/964	8	
373	N/732	750		380	N/965	12	
—	N/733	106		380	N/966	12	
373	N/741	715		380	N/967	12	
374	N/751	44		380	N/968	12	
374	N/761	130		380	N/969	10	
374	N/762	96		380	N/981	44	
—	N/765	64		380	N/982	44	
374	N/772	50		381	N/985	20	
375	N/801	46		381	N/985-1	20	
375	N/803	34		381	N/986	20	

PAG. N°	ART. N°	PREZZO LISTINO	PREZZO NETTO	PAG. N°	ART. N°	PREZZO LISTINO	PREZZO NETTO
381	N/991	76		387	N/1203	470	
381	N/992	76		388	N/1203-1	690	
381	N/1001	68		388	N/1204	470	
381	N/1002	100		388	N/1204-1	790	
381	N/1003	100		388	N/1205	490	
381	N/1004	124		—	N/1207	4.000	
381	N/1006	56		—	N/1207-1	2.000	
—	N/1008	64		—	N/1207-2	2.000	
381	N/1011	134		—	N/1208	7.500	
382	N/1012	78		—	N/1208-1	3.750	
382	N/1013	86		—	N/1208-2	3.750	
383	N/1071	1.650		389	N/1221	4.100	
383	N/1072	1.800		—	N/1225	6.100	
383	N/1073	1.800		389	N/1236	6.100	
383	N/1076	1.800		390	N/1251	3.250	
384	N/1077	550		390	N/1252	3.100	
—	N/1078	680		390	N/1253	2.600	
384	N/1081	1.050		390	N/1261	850	
384	N/1082	200		—	N/1270	2.000	
—	N/1083	312		—	N/1272	1.250	
384	N/1091	1.400		—	N/1274	880	
384	N/1092	1.800		—	N/1276	880	
384	N/1093	1.800		—	N/1278	2.500	
384	N/1094	1.800		—	N/1280	2.930	
384	N/1097	550		—	N/1282	1.000	
—	N/1098	320		—	N/1284	630	
—	N/1099	612		391	N/1399	38	
384	N/1101	1.300		391	N/1400	54	
385	N/1121	1.400		391	N/1401-2	150	
385	N/1122	1.650		391	N/1401-3	170	
385	N/1123	1.650		391	N/1401-4	226	
385	N/1125	1.440		391	N/1401-5	280	
—	N/1145	6.250		392	N/1402	490	
386	N/1151	1.750		392	N/1403	200	
—	N/1152	1.110		392	N/1404	300	
387	N/1161	500		392	N/1405	210	
387	N/1162	270		—	N/1406	500	
387	N/1171	2.700		—	N/1407	340	
—	N/1172	3.400		—	N/1408	276	
—	N/1173	3.400		—	N/1409	170	
387	N/1201	940		392	N/1416	420	
—	N/1201-1	810		392	N/1417	590	
387	N/1202	940		392	N/1418	220	
—	N/1202-1	810		—	N/1419	300	

PAG. N°	ART. N°	PREZZO LISTINO	PREZZO NETTO	PAG. N°	ART. N°	PREZZO LISTINO	PREZZO NETTO
—	N/1420	550		400	N/1602	150	
393	N/1422	730		400	N/1603	180	
393	N/1423	1.030		400	N/1606	240	
393	N/1424	1.030		400	N/1621	380	
393	N/1432	1.050		400	N/1622	380	
393	N/1433	1.190					
393	N/1434	1.190					
393	N/1435	1.190					
393	N/1436	1.190		402	O/1	210	
393	N/1443	1.190		402	O/2	210	
394	N/1445	800		402	O/3	210	
394	N/1446	1.150		402	O/11	110	
394	N/1447	1.150		402	O/12	110	
394	N/1452	1.050		402	O/13	130	
394	N/1453	1.150		402	O/14	140	
395	N/1462	1.100		—	O/16	110	
395	N/1463	1.250		—	O/17	120	
395	N/1472	870		402	O/21	50	
395	N/1473	1.100		402	O/31	100	
396	N/1476	250		402	O/41	620	
396	N/1477	280		402	O/42	720	
396	N/1478	690		402	O/43	750	
396	N/1479	690		402	O/44	920	
396	N/1480	1.600		402	O/45	1.440	
396	N/1481	1.770		402	O/46	1.840	
396	N/1482	1.770		403	O/51	700	
397	N/1483	270		403	O/52	700	
397	N/1484	270		403	O/61	770	
397	N/1485	820		403	O/62	700	
397	N/1486	820		403	O/71	700	
397	N/1487	770		403	O/72	700	
397	N/1488	770		403	O/73	900	
397	N/1489	770		403	O/74	900	
397	N/1490	770		403	O/76	800	
—	N/1580	1.150		403	O/77	800	
—	N/1581	750		404	O/82	800	
399	N/1591	1.600		404	O/83	830	
399	N/1592	2.000		404	O/84	930	
399	N/1593	2.250		404	O/86	830	
399	N/1594	2.400		404	O/87	780	
399	N/1595	2.500		405	O/101	1.000	
399	N/1596	2.800		405	O/102	1.000	
400	N/1601	70		405	O/103	1.000	

PAG. N°	ART. N°	PREZZO LISTINO	PREZZO NETTO	PAG. N°	ART. N°	PREZZO LISTINO	PREZZO NETTO
405	O/104	1.000		414	O/256	1.500	
405	O/105	1.000		415	O/301	970	
405	O/106	1.000		415	O/302	1.300	
405	O/107	1.250		416	O/303	1.350	
405	O/108	1.250		416	O/304	2.750	
405	O/109	1.250		—	O/311	2.100	
405	O/110	1.250		—	O/312	1.300	
406	O/121	730		—	O/313	1.150	
406	O/122	730		—	O/314	1.500	
406	O/121-1	1.050		—	O/315	5.100	
406	O/122-2	1.000		417	O/401	1.250	
406	O/122-3	1.100		417	O/402	1.250	
406	O/122-4	1.050		417	O/403	1.250	
406	O/122-5	1.150		417	O/404	1.250	
406	O/122-6	1.100		417	O/421	2.700	
407	O/123	740		419	O/462	1.700	
407	O/124	850		—	O/462-1	1.800	
408	O/126	980		419	O/463	2.650	
408	O/127	1.350		419	O/464	3.400	
409	O/128	1.300		—	O/465	3.800	
409	O/129	1.350		—	O/466	3.460	
410	O/131	750		420	O/481	330	
410	O/131-1	900		420	O/486	330	
410	O/131-2	880		420	O/491	250	
410	O/133	780		420	O/492	250	
411	O/141	1.300		420	O/496	250	
411	O/151	930		420	O/497	330	
411	O/152	1.050		420	O/497-1	1.500	
411	O/152-1	750		420	O/497-2	600	
411	O/153	1.170		420	O/497-3	700	
411	O/161	1.000		420	O/497-4	1.200	
411	O/162	1.200		—	O/498-1	130	
412	O/171	1.650		—	O/498-2	130	
412	O/172	950		—	O/498-3	130	
412	O/173	1.150		—	O/498-4	220	
413	O/201	950		—	O/498-5	330	
413	O/202	470		—	O/498-6	500	
413	O/203	560		—	O/498-7	100	
—	O/207	260		—	O/498-8	100	
414	O/241	980		421	O/502	690	
414	O/242	700		421	O/503	700	
414	O/251	820		421	O/504	780	
414	O/252	820		421	O/505	700	

PAG. N°	ART. N°	PREZZO LISTINO	PREZZO NETTO	PAG. N°	ART. N°	PREZZO LISTINO	PREZZO NETTO
422	O/506	860		426	O/620-2	20	
422	O/507	1.050		426	O/620-3	38	
422	O/508	1.250		426	O/620-4	28	
422	O/509	1.450		426	O/620-5	28	
422	O/510	1.650		426	O/620-6	28	
422	O/511	1.900		426	O/620-7	38	
—	O/517	1.400		426	O/620-8	20	
—	O/521	24		427	O/620-9	38	
—	O/522	24		427	O/620-10	28	
—	O/523	40		427	O/620-11	24	
423	O/601	300		427	O/620-12	30	
423	O/602	180		427	O/621	14	
423	O/603	200		427	O/621-1	30	
—	O/603-1	700		427	O/621-2	30	
424	O/604	42		427	O/621-3	24	
424	O/605	150		427	O/621-4	34	
424	O/606	110		427	O/621-5	48	
424	O/607	64		427	O/621-6	34	
424	O/608	50		427	O/621-7	28	
424	O/609	50		427	O/621-8	30	
424	O/610	66		427	O/621-9	34	
424	O/610-1	180		427	O/621-10	40	
424	O/611-1	44		427	O/621-11	26	
424	O/611-2	46		427	O/621-12	38	
425	O/611-3	44		428	O/621-13	40	
425	O/611-4	44		428	O/622	18	
425	O/611-5	66		428	O/623	20	
425	O/612	30		428	O/623-1	24	
425	O/613	30		428	O/623-2	34	
425	O/613-1	70		428	O/624	22	
425	O/613-2	44		428	O/624-1	20	
425	O/613-3	78		428	O/624-2	40	
425	O/613-4	70		428	O/624-3	40	
425	O/614	36		428	O/624-4	50	
425	O/614-1	80		428	O/625	22	
426	O/614-2	76		428	O/626	30	
426	O/615	30		428	O/626-1	90	
426	O/616	34		428	O/626-2	50	
426	O/617	40		428	O/627	26	
426	O/618	40		428	O/628	40	
426	O/619	30		428	O/629	40	
426	O/620	36		428	O/630	48	
426	O/620-1	34		428	O/631	58	

PAG. N°	ART. N°	PREZZO LISTINO	PREZZO NETTO	PAG. N°	ART. N°	PREZZO LISTINO	PREZZO NETTO
429	O/632	58		434	O/712	50	
429	O/633	150		434	O/713	40	
430	O/634	50		434	O/714	60	
430	O/635	38		434	O/715	50	
430	O/636	40		434	O/716	50	
430	O/638	44		434	O/717	50	
430	O/640	48		434	O/721	80	
430	O/640-1	48		434	O/731	54	
430	O/641	36		434	O/732	54	
430	O/641-1	48		434	O/733	60	
430	O/641-2	70		435	O/802	400	
430	O/642	60		435	O/803	400	
430	O/644	44		435	O/804	400	
431	O/651	4		435	O/805	750	
431	O/652	4		435	O/806	750	
431	O/653	4		435	O/809	400	
431	O/654	4		435	O/810	400	
431	O/661	14		435	O/821	300	
431	O/665	20		436	O/822	300	
431	O/666	20		—	O/823	300	
431	O/667	20		—	O/824	300	
431	O/668	30		—	O/825	300	
431	O/669	20		—	O/826-1	650	
431	O/670	24		436	O/827	850	
432	O/671	30		—	O/830	450	
432	O/672	20		—	O/831	500	
432	O/673	24		—	O/832	330	
432	O/674	24		436	O/835	850	
432	O/675	20		436	O/837	300	
432	O/676	20		436	O/838	850	
432	O/677	20		436	O/839	700	
433	O/681	40		436	O/840	400	
433	O/682	40		436	O/841	550	
433	O/683	36		436	O/842	1.000	
433	O/691	40		436	O/843	550	
433	O/692	40		437	O/905	880	
433	O/693	40		437	O/906	880	
433	O/694	40		437	O/907	620	
433	O/695	30		437	O/908	620	
433	O/701	40		437	O/909	620	
433	O/702	30		437	O/910	300	
433	O/703	40		438	O/931	2.200	
434	O/711	50		438	O/936	2.350	

PAG. N°	ART. N°	PREZZO LISTINO	PREZZO NETTO	PAG. N°	ART. N°	PREZZO LISTINO	PREZZO NETTO
438	O/937	1.500		—	P/10	2.200	
439	O/944	1.700		—	P/10-1	750	
439	O/945	2.350		—	P/10-2	750	
439	O/946	500		—	P/10-3	750	
439	O/947	2.900		—	P/10-4	2.100	
439	O/949	7.900		—	P/10-5	600	
—	O/950	3.000		—	P/10-6	600	
440	O/951	10		—	P/10-7	600	
440	O/952	12		—	P/11	2.200	
440	O/961	10		—	P/11-1	750	
440	O/962	10		—	P/11-2	750	
440	O/963	10		—	P/11-3	750	
440	O/964	14		—	P/15	750	
440	O/991	64		—	P/15-1	550	
441	O/1001	10		—	P/16	1.550	
441	O/1002	10		444	P/101	380	
441	O/1003	10		444	P/102	750	
441	O/1004	10		444	P/103	780	
441	O/1012	160		444	P/104	780	
441	O/1014	120		445	P/106	3.600	
441	O/1018	100		—	P/106-1	850	
441	O/1019	90		—	P/106-2	850	
441	O/1051	50		—	P/106-3	850	
442	O/1061	90		—	P/106-4	380	
—	O/1066-1	40		—	P/106-5	750	
—	O/1070	200		—	P/108	3.350	
442	O/1071	220		—	P/110	320	
442	O/1073	220		—	P/111	320	
442	O/1076	110		—	P/112	320	
442	O/1081	220		—	P/113	150	
443	O/1086	50		—	P/114	350	
443	O/1087	70		—	P/115	1.500	
443	O/1088	120		—	P/117-1	560	
443	O/1089	100		—	P/117-2	560	
443	O/1090	140		—	P/117-3	560	
443	O/1091	140		—	P/118	220	
	P			—	P/119	420	
—	P/2	700		446	P/121	3.600	
—	P/2-1	500		—	P/123	790	
—	P/3	700		—	P/130	950	
—	P/8	700		—	P/130-1	750	
				—	P/131	950	
				—	P/132	750	

PAG. Nº	ART. Nº	PREZZO LISTINO	PREZZO NETTO	PAG. Nº	ART. Nº	PREZZO LISTINO	PREZZO NETTO
—	P/134	2.700		451	P/185	620	
—	P/135	1.150		451	P/186	620	
—	P/136	1.250		—	P/211	620	
—	P/137	2.000		—	P/214	900	
446	P/141	750		—	P/215	900	
447	P/142	750		—	P/216	900	
447	P/151	1.000		—	P/217	900	
447	P/152	1.000		—	P/218	900	
447	P/152-2	1.370		—	P/219	900	
—	P/153	570		454	P/221	1.900	
—	P/154	1.200		454	P/222	2.950	
—	P/155	650		454	P/223	3.950	
—	P/156	720		454	P/224	4.850	
447	P/161	1.300		454	P/231	680	
447	P/162	1.600		454	P/236	850	
448	P/162-3	1.600		454	P/237	700	
448	P/162-5	1.600		—	P/237-1	830	
448	P/163	1.600		—	P/238	1.950	
448	P/163-13	1.650		—	P/239	1.700	
448	P/164-5	1.600		—	P/240	2.000	
448	P/165-5	2.450		—	P/242	1.800	
448	P/166	2.450		—	P/243-1	2.250	
—	P/166-1	1.800		—	P/243-2	2.000	
—	P/166-2	1.500		—	P/243-3	2.250	
—	P/166-3	1.800		—	P/243-4	1.950	
—	P/166-4	1.400		455	P/244	1.550	
—	P/166-5	1.800		—	P/245	1.500	
—	P/166-6	1.400		455	P/246	1.780	
—	P/166-7	850		455	P/247	2.000	
—	P/166-8	850		455	P/248	1.900	
448	P/167-5	3.700		455	P/249	2.000	
—	P/167-6	3.700		456	P/251	250	
448	P/168	2.500		456	P/253	250	
—	P/168-1	2.500		456	P/254	250	
—	P/168-2	1.000		—	P/256	420	
—	P/168-3	950		—	P/258	100	
—	P/168-4	950		—	P/261	250	
450	P/171	850		—	P/263	830	
450	P/172	850		—	P/264	580	
—	P/174	850		—	P/265	580	
—	P/175	850		—	P/266	660	
451	P/181	620		—	P/267	500	
451	P/182	620		—	P/268	500	

PAG. N°	ART. N°	PREZZO LISTINO	PREZZO NETTO	PAG. N°	ART. N°	PREZZO LISTINO	PREZZO NETTO
—	P/269	460		464	Q/42	17.600	
456	P/271	500		464	Q/43	20.800	
456	P/272	500		464	Q/44	29.800	
456	P/276	500		464	Q/51	18.700	
456	P/277	500		465	Q/52	6.800	
457	P/281	250		465	Q/53	6.700	
457	P/282	40		465	Q/56	8.100	
457	P/283	60		465	Q/61	10.800	
457	P/292	500		465	Q/66	7.600	
457	P/292-1	500		465	Q/71	21.600	
457	P/293	500		—	Q/92	17.000	
457	P/293-1	500		466	Q/101	38.800	
457	P/294	500		467	Q/111	11.000	
—	P/294-1	500		—	Q/115	5.000	
458	P/311	2.150		467	Q/121	66.000	
458	P/312	2.150		467	Q/131	66.000	
458	P/313	2.150		—	Q/152	2.500	
458	P/314	2.150		468	Q/161	3.200	
	Q			468	Q/171	2.750	
				468	Q/181	3.900	
				469	Q/203	23.800	
460	Q/1	3.200		469	Q/204	23.800	
—	Q/3	7.000		469	Q/211	23.600	
—	Q/5	7.500		469	Q/221	1.300	
460	Q/6	9.200		469	Q/222	1.300	
460	Q/11	1.500		469	Q/226	1.300	
460	Q/12	2.100		469	Q/231	1.750	
461	Q/21	17.700		470	Q/232	3.800	
461	Q/22	16.000		470	Q/233	3.800	
461	Q/23	6.200		470	Q/234	3.800	
461	Q/24	6.700		470	Q/241	3.700	
461	Q/31	9.500		470	Q/242	3.700	
461	Q/32	12.800		470	Q/243	4.300	
462	Q/33	8.800		470	Q/244	4.300	
462	Q/36	14.800		471	Q/251	4.100	
462	Q/37	21.400		471	Q/252	3.400	
462	Q/37-1	19.400		471	Q/261	3.400	
463	Q/38	55.800		471	Q/262	3.400	
463	Q/38-1	44.800		471	Q/263	3.500	
463	Q/38-2	39.000		471	Q/264	3.500	
463	Q/39	56.000		471	Q/271	3.700	
464	Q/41	15.800		472	Q/272	3.400	
				472	Q/273	3.400	

PAG. N°	ART. N°	PREZZO LISTINO	PREZZO NETTO	PAG. N°	ART. N°	PREZZO LISTINO	PREZZO NETTO
472	Q/274	3.300		476	Q/477	8.700	
472	Q/275	3.700		—	Q/477-1	9.800	
472	Q/276	3.400		—	Q/477-2	9.600	
472	Q/277	4.400		476	Q/478	7.600	
472	Q/278	3.800		476	Q/479	4.900	
606	Q/290	9.900		476	Q/480	4.500	
606	Q/291	9.900		476	Q/481	7.850	
606	Q/292	6.750		477	Q/491	3.100	
473	Q/361	7.600		477	Q/492	3.200	
473	Q/366	4.000		477	Q/493	16.800	
473	Q/367	6.700		477	Q/501	1.450	
473	Q/368	3.400		—	Q/508	28.750	
473	Q/369	5.500		—	Q/510	2.850	
473	Q/370	3.700		—	Q/512	8.300	
473	Q/381	3.500		—	Q/514	1.400	
473	Q/382	1.900		478	Q/601	870	
473	Q/391	950		478	Q/602	960	
474	Q/401	2.700		478	Q/603	840	
—	Q/405	1.700		478	Q/604	40	
—	Q/406	1.700		478	Q/611	84	
—	Q/407	1.700		478	Q/612	116	
—	Q/408	1.700		478	Q/613	126	
—	Q/409	1.700		479	Q/614	510	
—	Q/410	1.700		479	Q/615	510	
474	Q/420	1.480		479	Q/616	430	
474	Q/421	4.700		—	Q/618	750	
474	Q/431	1.250		479	Q/619	270	
—	Q/433	500		479	Q/620	470	
—	Q/434	600		479	Q/621	130	
474	Q/436	4.100		479	Q/622	130	
475	Q/440	500		479	Q/623	170	
475	Q/443	1.800		479	Q/624	126	
—	Q/444	1.500		480	Q/631	380	
—	Q/445	2.400		480	Q/632	640	
—	Q/446	2.200		480	Q/633	640	
—	Q/447	7.500		480	Q/635	950	
—	Q/448	8.300		480	Q/636	820	
—	Q/449	9.000		480	Q/651	400	
—	Q/450	7.000		481	Q/652	730	
475	Q/451	12.400		481	Q/653	770	
475	Q/452	11.300		481	Q/654	870	
476	Q/471	7.500		481	Q/655	380	
476	Q/476	6.250		481	Q/656	730	

PAG. N°	ART. N°	PREZZO LISTINO	PREZZO NETTO	PAG. N°	ART. N°	PREZZO LISTINO	PREZZO NETTO
482	Q/661	1.050		—	R/132	—	
482	Q/662	900		—	R/134	2.250	
482	Q/663	1.340		488	R/141	—	
482	Q/664	1.200		488	R/142	—	
482	Q/665	600		489	R/151	—	
482	Q/666	250		489	R/152	—	
482	Q/667	1.500		—	R/222-2	—	
482	Q/668	1.500		—	R/223-2	—	
483	Q/669	1.500		490	R/231	—	
483	Q/670	1.800		490	R/232	—	
483	Q/671	530		490	R/241	—	
483	Q/672	450		490	R/242	—	
—	Q/690	3.000		491	R/246	—	
—	Q/692	3.000		491	R/251	—	
	R			492	R/501	250	
484	R/1-1	—		492	R/502	2.200	
484	R/1-2	—		492	R/505	30	
484	R/1-3	—		492	R/506	30	
484	R/1-4	—		492	R/507	1.200	
485	R/2	—		492	R/508	550	
485	R/2-1	—		492	R/509	30	
485	R/3	—		492	R/510	430	
485	R/6	—		492	R/511	430	
486	R/7	—		492	R/512	430	
486	R/11	4.300		492	R/513	500	
—	R/18	—		492	R/514	130	
486	R/21	—		492	R/515	2.300	
—	R/25	—		492	R/516	2.200	
—	R/26	—		493	R/517	400	
—	R/54	—		493	R/518	1.800	
—	R/57	—		493	R/519	470	
—	R/60	—		493	R/520	150	
—	R/63	—		493	R/522	160	
—	R/65	—		493	R/523	500	
—	R/70	—		494	R/551	2.000	
487	R/81	—		494	R/552	500	
—	R/86	3.900		494	R/553	500	
487	R/101	—		494	R/554	150	
—	R/106-1	—		494	R/555	350	
—	R/109	—		494	R/556	210	
				494	R/557	30	
				494	R/558	390	
				494	R/559	290	

PAG. N°	ART. N°	PREZZO LISTINO	PREZZO NETTO	PAG. N°	ART. N°	PREZZO LISTINO	PREZZO NETTO
494	R/560	140		500	R/704	110	
494	R/561	2.300		500	R/705	40	
494	R/562	2.200		500	R/706	390	
494	R/563	390		500	R/707	520	
494	R/564	26		500	R/708	130	
495	R/601	26		500	R/709	1.500	
495	R/602	2.000		500	R/710	200	
495	R/603	160		500	R/712	130	
495	R/604	500		501	R/713	150	
495	R/606	1.050		501	R/714	150	
495	R/607	1.850		501	R/715	50	
496	R/608	160		501	R/716	150	
496	R/610	2.000		501	R/717	200	
496	R/611	500		501	R/718	50	
496	R/612	2.300		501	R/719	200	
496	R/613	210		501	R/720	160	
496	R/614	20		501	R/721	300	
496	R/615	390		501	R/722	2.200	
496	R/616	290		501	R/723	400	
496	R/618	140		501	R/724	40	
496	R/619	2.200		501	R/725	50	
496	R/620	390		501	R/726	30	
496	R/601	26		501	R/727	60	
498	R/651	470		501	R/728	100	
498	R/652	160		501	R/729	200	
498	R/653	390		501	R/730	1.600	
498	R/655	1.400		501	R/731	600	
498	R/656	570		502	R/801	500	
498	R/657	2.250		502	R/802	220	
498	R/658	26		502	R/803	56	
498	R/659	280		502	R/804	1.500	
498	R/660	130		502	R/805	2.100	
498	R/661	2.200		502	R/806	2.530	
498	R/662	380		502	R/807	2.100	
499	R/663	2.000		502	R/808	56	
499	R/664	150		502	R/809	276	
499	R/665	580		502	R/810	990	
499	R/666	20		502	R/811	2.530	
499	R/668	1.000		502	R/812	440	
499	R/669	2.300		503	R/813	990	
500	R/701	2.200		503	R/814	2.100	
500	R/702	460		503	R/815	1.050	
500	R/703	150		503	R/816	770	

PAG. N°	ART. N°	PREZZO LISTINO	PREZZO NETTO	PAG. N°	ART. N°	PREZZO LISTINO	PREZZO NETTO
503	R/817	300		506	R/914	3.000	
503	R/818-1	3.000		506	R/915	250	
503	R/819	5.400		506	R/917	900	
503	R/820	990		506	R/918	4.800	
503	R/821	390		506	R/919	2.000	
503	R/822	500		507	R/920	220	
503	R/823	110		507	R/921	220	
503	R/824	1.100		507	R/922	1.000	
503	R/825	220		507	R/923	700	
503	R/826	270		507	R/924	150	
503	R/827	110		507	R/925	100	
504	R/851	550		507	R/926	250	
504	R/852	1.300		507	R/928	60	
504	R/853	800		507	R/929	680	
504	R/854	400		507	R/930	2.500	
504	R/855	1.200		507	R/931	280	
504	R/856	1.000		507	R/932	450	
504	R/857	2.400		507	R/933	880	
504	R/858	400		507	R/934	1.200	
504	R/859	680		507	R/935	150	
504	R/860	4.800		—	R/940	2.350	
504	R/861	1.500		—	R/941	3.500	
504	R/862	550		—	R/943	1.500	
504	R/863	1.300		—	R/944	5.500	
505	R/864	500		—	R/945	250	
505	R/865	7.800		—	R/946	200	
505	R/866	680		—	R/947	220	
505	R/867	400		—	R/948	250	
505	R/869	1.000		—	R/960	300	
505	R/870	4.400		—	R/961	600	
505	R/871	120		—	R/965	400	
505	R/872	4.600		—	R/966	400	
506	R/901	30		—	R/967	80	
506	R/902	1.000		—	R/968	500	
506	R/903	950		—	R/1100	1.200	
506	R/904	950		—	R/1150	300	
506	R/905	2.200		509	R/1201	8.300	
506	R/906	950		509	R/1206	2.000	
506	R/907	950		—	R/1206-1	2.000	
506	R/908	680		509	R/1208	2.000	
506	R/910	300		—	R/1208-1	2.100	
506	R/912	30		509	R/1209	2.000	
506	R/913	150		509	R/1210	10.850	

PAG. Nº	ART. Nº	PREZZO LISTINO	PREZZO NETTO	PAG. Nº	ART. Nº	PREZZO LISTINO	PREZZO NETTO
509	R/1211	4.200		515	R/1381	7.000	
—	R/1212	4.400		515	R/1382	7.100	
509	R/1213	4.200		515	R/1388	29.000	
—	R/1216	1.000		515	R/1389	7.100	
—	R/1217	1.350		515	R/1390	10.000	
—	R/1218	1.500		516	R/1391	6.200	
509	R/1221	260		516	R/1392	6.200	
—	R/1227	4.230		516	R/1394	30.000	
510	R/1231	390		516	R/1398	7.900	
510	R/1241	36.400		—	R/1400	8.420	
510	R/1243	14.000		516	R/1406	13.000	
510	R/1245	16.500		516	R/1407	44.000	
511	R/1303	6.900		516	R/1408	40.000	
511	R/1304	7.100		516	R/1409	33.800	
512	R/1311	4.500		517	R/1411	3.400	
512	R/1316	3.900		517	R/1412	1.900	
512	R/1317	3.200		—	R/1414	4.500	
512	R/1319	6.300		—	R/1415	4.500	
513	R/1325	7.650		517	R/1421	3.000	
513	R/1327	13.300		517	R/1422	3.000	
513	R/1329	6.300		517	R/1423	6.800	
513	R/1330	10.300		518	R/1425	7.500	
513	R/1331	28.400		518	R/1426	3.500	
513	R/1332	6.300		518	R/1427	11.500	
513	R/1333	10.300		518	R/1428	6.000	
513	R/1334	28.400		518	R/1430	30.400	
514	R/1343	2.800		519	R/1433	26.000	
—	R/1343-1	2.800		519	R/1434	11.000	
—	R/1344	4.200		519	R/1441	1.700	
514	R/1346	2.800		—	R/1442	2.500	
—	R/1347	5.800		520	R/1501	210	
—	R/1348	3.000		—	R/1501-1	3.750	
—	R/1353	10.500		520	R/1502	210	
—	R/1354	16.700		520	R/1511	240	
514	R/1357	1.250		—	R/1511-1	3.750	
514	R/1358	8.250		520	R/1512	240	
515	R/1361	5.830		520	R/1521	240	
515	R/1362	990		—	R/1521-1	3.750	
515	R/1363	4.950		520	R/1522	240	
515	R/1366	7.260		520	R/1531	300	
515	R/1367	10.120		520	R/1532	300	
515	R/1377	4.000		520	R/1533	480	
515	R/1878	8.000		521	R/1535	600	

PAG. N°	ART. N°	PREZZO LISTINO	PREZZO NETTO	PAG. N°	ART. N°	PREZZO LISTINO	PREZZO NETTO
—	R/1536	270		—	R/1609-1	1.200	
—	R/1536-1	270		—	R/1610	480	
—	R/1537	420		—	R/1610-1	480	
—	R/1537-1	420		—	R/1611-1	300	
—	R/1537-3	480		—	R/1611-2	300	
—	R/1538	350		522	R/1612	240	
—	R/1538-1	350		522	R/1613	240	
—	R/1539	270		—	R/1614	300	
—	R/1539-1	270		522	R/1615	270	
—	R/1540	300		522	R/1616	270	
—	R/1540-1	300		—	R/1617	600	
521	R/1541	600		—	R/1617-1	540	
521	R/1551	300		—	R/1618	510	
521	R/1552	300		—	R/1618-1	510	
—	R/1553	480		—	R/1618-2	480	
—	R/1554	480		—	R/1618-3	480	
—	R/1556	600		—	R/1619	480	
—	R/1558	660		—	R/1619-1	480	
—	R/1559	660		—	R/1620	900	
521	R/1561	300		—	R/1620-1	360	
521	R/1562	300		522	R/1621	600	
521	R/1565	600		522	R/1631	510	
521	R/1566	600		—	R/1632	900	
—	R/1567	240		—	R/1633	600	
—	R/1568	240		—	R/1634	390	
—	R/1569	600		—	R/1634-1	390	
521	R/1571	300		—	R/1634-2	630	
521	R/1572	300		—	R/1634-3	630	
522	R/1581	300		—	R/1634-4	630	
522	R/1582	300		—	R/1634-5	630	
—	R/1585	300		—	R/1634-6	630	
522	R/1591	600		—	R/1635	570	
522	R/1601	270		—	R/1635-1	690	
522	R/1602	270		—	R/1635-2	690	
522	R/1603	300		—	R/1635-3	570	
—	R/1603-1	3.750		—	R/1635-4	690	
522	R/1604	300		—	R/1635-5	2.100	
—	R/1605	270		—	R/1635-6	2.550	
—	R/1605-1	270		—	R/1635-7	2.550	
522	R/1606	3.750		—	R/1636	270	
522	R/1607	480		—	R/1636-1	270	
—	R/1608	720		—	R/1637	840	
—	R/1609	1.200		—	R/1638	840	

PAG. Nº	ART. Nº	PREZZO LISTINO	PREZZO NETTO	PAG. Nº	ART. Nº	PREZZO LISTINO	PREZZO NETTO
—	R/1639	2.700		523	R/1692	300	
—	R/1640	3.750		523	R/1697	600	
—	R/1640-1	1.200		—	R/1698	300	
523	R/1641	450		—	R/1698-1	300	
—	R/1642	810		—	R/1699	400	
—	R/1643	850		—	R/1699-1	400	
—	R/1644	550		—	R/1700	330	
—	R/1644-1	550		—	R/1700-1	330	
—	R/1645	680		—	R/1700-5	400	
—	R/1645-1	680		524	R/1701	300	
—	R/1646	510		524	R/1702	300	
—	R/1646-1	510		524	R/1703	240	
—	R/1647	350		524	R/1704	240	
—	R/1647-1	350		524	R/1705	480	
—	R/1648	2.850		—	R/1706	660	
523	R/1650	600		—	R/1707	660	
523	R/1651	390		524	R/1721	380	
—	R/1651-1	3.750		524	R/1722	380	
523	R/1652	390		524	R/1741	380	
—	R/1654	600		524	R/1742	380	
—	R/1655	3.750		524	R/1743	380	
—	R/1656	900		524	R/1744	380	
—	R/1657	900		524	R/1745	3.750	
—	R/1658	900		524	R/1746	600	
—	R/1659	1.140		524	R/1747	300	
523	R/1661	490		—	R/1747-1	390	
523	R/1662	490		—	R/1747-2	390	
—	R/1663	3.750		525	R/1748	660	
523	R/1681	480		525	R/1749	660	
523	R/1682	540		—	R/1752	300	
523	R/1683	540		—	R/1752-1	300	
—	R/1684	450		—	R/1753	480	
—	R/1684-1	450		—	R/1754	480	
—	R/1685	240		—	R/1755	630	
—	R/1685-1	240		—	R/1756	360	
—	R/1686	540		—	R/1756-1	360	
—	R/1686-1	540		—	R/1757	570	
—	R/1687	240		—	R/1757-1	570	
—	R/1687-1	240		—	R/1758	690	
—	R/1688	540		—	R/1758-1	690	
—	R/1689	540		—	R/1759	270	
—	R/1689-1	540		—	R/1760	300	
523	R/1691	300		—	R/1760-1	300	

PAG. N°	ART. N°	PREZZO LISTINO	PREZZO NETTO	PAG. N°	ART. N°	PREZZO LISTINO	PREZZO NETTO
—	R/1762	360		527	R/1803	1.600 ‰	
—	R/1762-1	360		527	R/1804	2.100 ‰	
—	R/1763	900		527	R/1805	2.100 ‰	
—	R/1767	4.200		527	R/1841	1.900 ‰	
—	R/1768	4.200		527	R/1845	1.500 ‰	
525	R/1771	510		528	R/1861	570	
525	R/1772	510		528	R/1862	300	
525	R/1777	376		529	R/1882	1.800	
525	R/1779	3.750		529	R/1883	5.500	
525	R/1780	376		529	R/1902	1.800	
525	R/1781	376		—	R/1903	1.800	
525	R/1782	3.750		529	R/1911	550	
525	R/1783	376		529	R/1921	780	
—	R/1784	840		529	R/1951	500	
—	R/1784-3	690		—	R/1966	4.000	
—	R/1784-4	690		—	R/1980	6.600	
525	R/1785	360		—	R/1981	220	
525	R/1786	360		—	R/1982	480	
526	R/1788	450		530	R/2101	550	
526	R/1789	450		530	R/2103	14	
—	R/1790	330		530	R/2104	14	
—	R/1790-1	330		530	R/2105	2.200	
—	R/1790-3	500		530	R/2106	2.500	
526	R/1791	1.050		530	R/2107	130	
526	R/1792	1.050		530	R/2108	40	
526	R/1793	630		530	R/2109	400	
526	R/1794	630		530	R/2110	440	
526	R/1795	300		530	R/2111	70	
—	R/1795-1	3.750		531	R/2121	3.200	
526	R/1796	300		531	R/2122	4.100	
—	R/1797	720		531	R/2123	4.100	
—	R/1797-1	570		531	R/2124	3.200	
—	R/1797-5	600		—	R/2125	2.500	
—	R/1797-6	1.200		—	R/2126	4.000	
526	R/1798	570		—	R/2127	3.500	
526	R/1799	570		531	R/2151	850	
—	R/1799-3	800		531	R/2152	850	
—	R/1799-4	800		531	R/2153	850	
—	R/1799-6	1.200		531	R/2161	850	
—	R/1799-8	800		531	R/2162	850	
—	R/1799-9	800		531	R/2163	850	
—	R/1800	300		531	R/2171	850	
—	R/1800-1	300		531	R/2172	850	

PAG. N°	ART. N°	PREZZO LISTINO	PREZZO NETTO	PAG. N°	ART. N°	PREZZO LISTINO	PREZZO NETTO
531	R/2173	850		—	S/216	—	
531	R/2181	950		538	S/301	1.500	
531	R/2182	950		538	S/302	1.150	
531	R/2183	950		538	S/303	2.250	
532	R/2201	1.300		538	S/311	5.000	
532	R/2202	1.300		538	S/312	5.000	
532	R/2206	1.300		538	S/313	2.500	
532	R/2207	1.300		538	S/314	5.000	
532	R/2211	1.300		538	S/315	5.000	
532	R/2212	1.300		538	S/316	2.500	
532	R/2221	3.700		539	S/321	9.900	
—	R/2222	3.700		539	S/322	7.500	
—	R/2223	3.750		539	S/331	2.750	
532	R/2231	3.300		539	S/332	1.500	
532	R/2232	3.300		539	S/336	7.600	
532	R/2241	500		—	S/337	3.800	
532	R/2242	500		540	S/340	—	
532	R/2245	2.126		540	S/341	750	
532	R/2271	1.100		540	S/342	750	
532	R/2272	950		541	S/351	6.400	
532	R/2276	1.700		541	S/352	6.400	
532	R/2281	900		541	S/353	6.400	
533	R/2501	120		541	S/354	6.400	
533	R/2502	300		541	S/355	2.500	
533	R/2503	160		541	S/356	2.500	
533	R/2521	150		541	S/357	2.500	
533	R/2531	40		541	S/358	3.800	
533	R/2541	12		542	S/361	5.500	
533	R/2551	30		542	S/362	5.000	
				542	S/363	10.500	
	S			542	S/371	800	
				542	S/376	550	
534	S/161	—		—	S/376-1	900	
534	S/171	—		—	S/377-1	900	
534	S/181	—		—	S/378	1.650	
535	S/182	—		—	S/379	1.650	
535	S/183	—		542	S/381	1.000	
536	S/201	—		542	S/382	2.900	
536	S/202	1.700		—	S/472	4.500	
536	S/203	1.700		543	S/601	80	
536	S/204	6.300		543	S/601-1	140	
537	S/211	—		543	S/601-2	100	
537	S/212	—		543	S/601-3	150	

PAG. N°	ART. N°	PREZZO LISTINO	PREZZO NETTO	PAG. N°	ART. N°	PREZZO LISTINO	PREZZO NETTO
543	S/602	160		546	S/720-1	300	
543	S/603	260		—	S/721	2.800	
—	S/603-1	160		547	S/723	7.800	
543	S/604	280					
543	S/605	700			T		
543	S/606	90					
543	S/607	1.500		548	T/1	626	
543	S/608	250		548	T/2	626	
543	S/609	750		548	T/16	2.000	
543	S/610	400		548	T/21	400	
544	S/625	590		548	T/22	400	
544	S/625-1	660		548	T/23	400	
544	S/625-2	890		—	T/35	200	
544	S/628	1.290		548	T/41	600	
544	S/628-1	1.950		548	T/51	600	
544	S/631	2.550		548	T/61	500	
544	S/626	880		609	T/120	74.000	
544	S/626-1	980		554	T/121	—	
544	S/626-2	1.200		554	T/122	—	
544	S/629	1.650		554	T/123	—	
544	S/629-1	2.450		555	T/131	—	
544	S/632	3.300		555	T/132	—	
544	S/627	2.100		555	T/133	—	
544	S/627-1	2.700		555	T/141	—	
544	S/627-2	3.100		556	T/161	—	
544	S/630	4.800		557	T/181	—	
544	S/630-1	6.800		557	T/191	—	
544	S/633	9.500		557	T/201	—	
545	S/651	720		558	T/211	—	
—	S/651-1	980		558	T/221	—	
545	S/653	1.860		559	T/231	—	
545	S/655	2.880		559	T/232	—	
545	S/657	3.540		559	T/233	—	
545	S/652	1.020		560	T/234	—	
545	S/654	2.340		560	T/235	—	
545	S/656	3.480		561	T/236	—	
545	S/658	4.740		561	T/237	—	
—	S/658-1	3.650		562	T/238	—	
545	S/659	5.550		562	T/239	—	
—	S/717	10.900		562	T/240	—	
546	S/718	12.400		562	T/241	—	
546	S/719	850		562	T/241	—	
546	S/720	1.500		563	T/242	—	

PAG. N°	ART. N°	PREZZO LISTINO	PREZZO NETTO	PAG. N°	ART. N°	PREZZO LISTINO	PREZZO NETTO
563	T/243	—		568	T/375	—	
563	T/244	—		568	T/383	—	
564	T/245	—		568	T/385	—	
564	T/246	—		568	T/404	—	
—	T/247	—		568	T/405	—	
564	T/248	—		568	T/411	—	
565	T/249	—		568	T/413	—	
565	T/250	—		568	T/414	—	
565	T/251	—		568	T/415	—	
—	T/260	—		568	T/421	—	
—	T/261	—		568	T/423	—	
566	T/281	—		568	T/424	—	
—	T/281-1	—		568	T/425	—	
566	T/282	—		568	T/443	—	
—	T/282-1	—		568	T/444	—	
566	T/283	—		568	T/445	—	
567	T/285	—		568	T/453	—	
567	T/286	—		568	T/454	—	
567	T/287	—		568	T/455	—	
567	T/288	—		568	T/463	—	
567	T/289	—		568	T/464	—	
567	T/290	—		568	T/465	—	
568	T/302	—		568	T/483	—	
568	T/312	—		568	T/484	—	
568	T/321	—		568	T/485	—	
568	T/322	—		568	T/491	—	
568	T/323	—		568	T/493	—	
568	T/324	—		568	T/494	—	
568	T/325	—		568	T/495	—	
568	T/331	—		568	T/501	—	
568	T/332	—		568	T/503	—	
568	T/333	—		568	T/504	—	
568	T/334	—		568	T/505	—	
568	T/335	—		568	T/531	—	
568	T/352	—		568	T/532	—	
568	T/354	—		570	T/541	—	
568	T/355	—		570	T/542	—	
568	T/361	—		570	T/544	—	
568	T/363	—		570	T/551	—	
568	T/371	—		570	T/552	—	
568	T/372	—		570	T/553	—	
568	T/373	—		570	T/554	—	
568	T/374	—		—	T/557	—	

PAG. N°	ART. N°	PREZZO LISTINO	PREZZO NETTO	PAG. N°	ART. N°	PREZZO LISTINO	PREZZO NETTO
—	T/560 c.b.	—		575	U/256	450	
—	T/561 c.b.	—		—	U/256-1	150	
—	T/570 c.b.	—		—	U/256-2	150	
—	T/571 c.b.	—		575	U/257	160	
—	T/572 c.b.	—		575	U/258	186	
—	T/573	—		575	U/259	300	
	U			575	U/260	336	
				575	U/261	350	
				576	U/262	260	
				576	U/271	62	
572	U/1	8.000		576	U/272	120	
572	U/31	3.800		576	U/281	220	
572	U/50	2.600		576	U/282	290	
573	U/52-1	1.700		576	U/291	270	
573	U/53	2.600		576	U/292	350	
573	U/55	2.600		576	U/301	300	
573	U/56	1.900		576	U/302	400	
573	U/67	2.700		576	U/311	350	
573	U/68	1.800		576	U/312	450	
573	U/69	2.100		577	U/321	84	
573	U/70	2.100		577	U/322	110	
—	U/71	1.600		577	U/331	84	
—	U/72	2.200		577	U/332	110	
—	U/73	3.300		577	U/341	84	
—	U/75	2.100		577	U/342	110	
—	U/76	3.300		577	U/351	84	
—	U/78	1.500		577	U/352	110	
—	U/79	2.300		577	U/361	50	
—	U/95	1.600		577	U/362	100	
—	U/96	1.600		577	U/371	84	
—	U/97	1.600		577	U/372	110	
—	U/98	1.600		577	U/381	84	
574	U/209	550		577	U/382	110	
574	U/210	1.000		578	U/386	900	
574	U/211	550		578	U/387	800	
574	U/212	550		578	U/391	200	
574	U/221	160		578	U/401	1.540	
574	U/222	80		578	U/411	1.760	
575	U/251	50		579	U/422	150	
575	U/252	60		579	U/424	170	
575	U/253	90		580	U/451	2.200	
575	U/254	120		580	U/452	1.500	
575	U/255	170		580	U/453	2.400	

PAG. N°	ART. N°	PREZZO LISTINO	PREZZO NETTO	PAG. N°	ART. N°	PREZZO LISTINO	PREZZO NETTO
580	U/454	2.100		593	Z/167	—	
580	U/455	2.000		594	Z/182	53.000	
581	U/459	4.900		594	Z/183	103.000	
—	U/461-1	2.100		594	Z/186	18.100	
—	U/462-1	2.150		—	Z/187	16.900	
—	U/463-1	2.150		—	Z/190	39.500	
—	U/464-1	1.900		595	Z/202	12.000	
—	U/465	1.100		595	Z/203	16.500	
—	U/465-2	2.350		595	Z/204	33.500	
—	U/465-3	2.350		595	Z/205	48.800	
583	U/466	650		595	Z/206	41.800	
583	U/467	550		596	Z/207	111.000	
583	U/468	500		596	Z/212	41.800	
583	U/469	500		596	Z/213	23.800	
583	U/471	750		596	Z/214	64.400	
583	U/472	1.000		597	Z/241	—	
583	U/473	870		—	Z/254	30.000	
583	U/477	700		—	Z/256	—	
583	U/478	700		—	Z/260	4.800	
583	U/479	500		599	Z/261	11.800	
583	U/481	7.500		599	Z/262	29.000	
583	U/491	7.200		599	Z/263	10.300	
583	U/501	8.700		599	Z/264	19.000	
	Z			599	Z/265	10.300	
				599	Z/266	19.000	
				599	Z/267	16.500	
				599	Z/268	36.000	
584	Z/81	—		600	Z/269	28.500	
584	Z/91	—		600	Z/270	48.000	
585	Z/101	—		600	Z/276	31.000	
585	Z/111	—		600	Z/277	53.000	
586	Z/116	—		601	Z/278	28.000	
587	Z/121	—		601	Z/279	49.000	
588	Z/131	—		—	Z/281	88.000	
589	Z/141	—		—	Z/300	178.000	
589	Z/151	—		—	Z/301	45.000	
590	Z/153	—		—	Z/302	79.000	
590	Z/154	—		—	Z/303	39.000	
591	Z/156	—		602	Z/390	16.000	
591	Z/157	—		602	Z/391	11.000	
591	Z/158	—		—	Z/440	—	
592	Z/161	—		—	Z/450	22.500	
593	Z/166	—		—	Z/451	43.500	

PAG. N°	ART. N°	PREZZO LISTINO	PREZZO NETTO	PAG. N°	ART. N°	PREZZO LISTINO	PREZZO NETTO
—	Z/1122	10.800					
—	Z/1133	39.000					
—	Z/1134	10.900					
—	Z/5100	—					
—	Z/5101	—					
—	Z/5106	—					
—	Z/5107	—					
—	Z/5110	—					
—	Z/5111	—					
—	Z/5116	—					
—	Z/5117	—					
—	Z/5119	—					
—	Z/5121	—					
—	Z/5122	—					
—	Z/5125	—					
—	Z/5126	—					
—	Z/5128	—					
—	Z/5129	—					

Tutti i numeri delle pagine

si riferiscono al

“Catalogo Generale” 1931 - 1959

CONDENSATORI CON DIELETTRICO IN POLIESTERE PER RADIO ED APPARECCHIATURE ELETTRONICHE



POLYESTER CAPACITORS FOR RADIO AND ELECTRONICS EQUIPEMENTS

Type Tipo	Capacitance Capacità		D.C. Working voltage V Tensione di lavoro	Dimensions in mm Dimensioni in mm				Catalog No Numero di Catalogo	Prezzo Listino Lit.
				D	L	d	l		
Copo 1000/600	1000 pF	1 nF	600	7	19	0,6	40	B/160	40
» 1500/600	1500 pF	1,5 nF	600	7	19	0,6	40	B/161	40
» 2200/600	2200 pF	2,2 nF	600	7	19	0,6	40	B/162	40
» 3300/400	3300 pF	3,3 nF	400	7	19	0,6	40	B/165	40
» 4700/400	4700 pF	4,7 nF	400	7	19	0,6	40	B/166	40
» 6800/400	6800 pF	6,8 nF	400	7	19	0,6	40	B/167	40
» 0,01/400	0,01 μ F	10 nF	400	8	19	0,6	40	B/168	40
» 0,015/400	15000 pF	15 nF	400	9	19	0,7	40	B/169	40
» 0,022/400	22000 pF	22 nF	400	9	21	0,7	40	B/170	48
» 0,033/400	33000 pF	33 nF	400	10	21	0,7	40	B/171	54
» 0,047/400	47000 pF	47 nF	400	11	21	0,7	40	B/172	60
» 0,068/400	68000 pF	68 nF	400	10	28	0,7	40	B/173	68
» 0,1/400	100000 pF	100 nF	400	11	28	0,7	40	B/174	76

SUITABLE FOR NORMAL MOUNTING AND FOR PRINTED CIRCUIT

ADATTI PER MONTAGGIO NORMALE E PER CIRCUITI STAMPATI

THE **BULGIN** CATALOGUE



Electronic Components

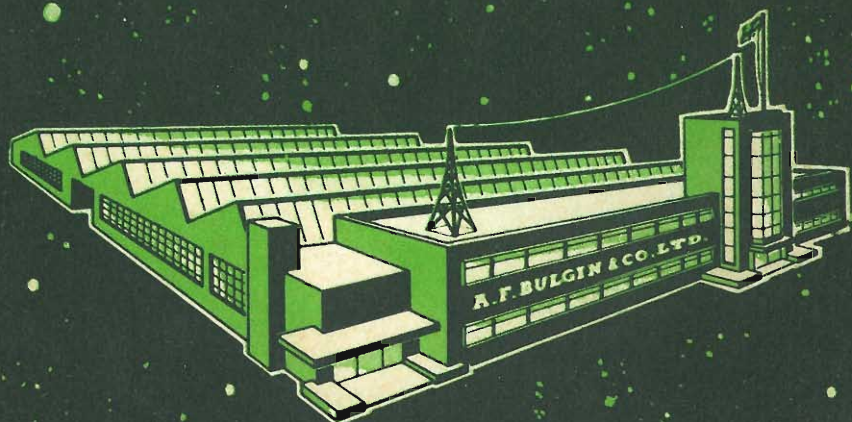

A.F. BULGIN & CO. LTD BYE-PASS ROAD, BARKING, ESSEX

Our 164 page technical catalogue published in MARCH 1960 contains illustrations, full working details and dimensions of over 10,000 ELECTRONIC COMPONENTS and includes all the new lines and developments announced during the past year. Available free on request to all Manufacturers and Electronic Engineers WHO HAVE NOT ALREADY APPLIED.

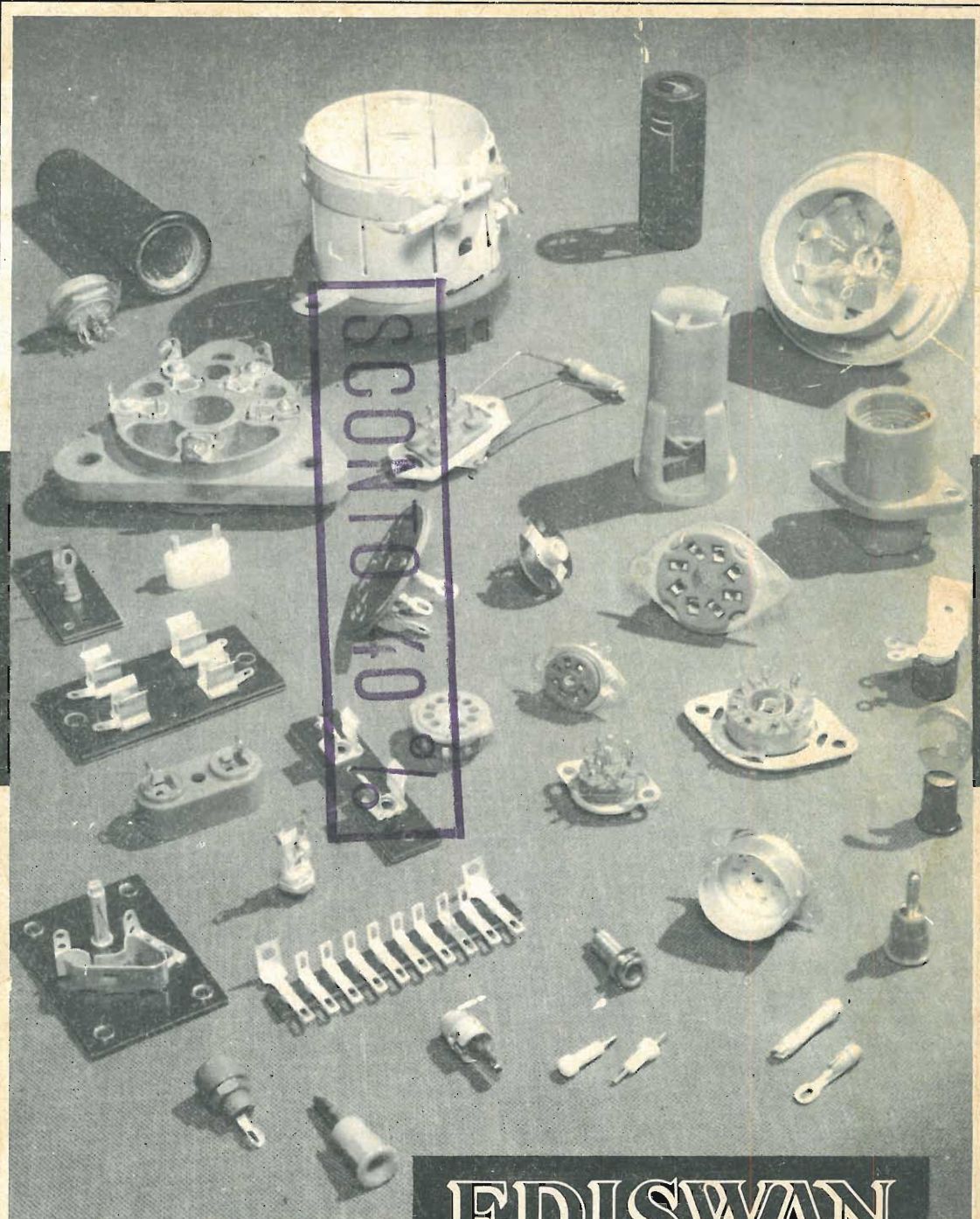

EDISWAN

Parti staccate di qualità

EDISWAN - ASSOCIATED ELECTRICAL INDUSTRIES

155, CHARING CROSS ROAD - LONDON, W.C.2

"SELEZIONE DI TECNICA RADIO - TV: L. 400